

ILLUMINATIONS EDF2DBAD

Illuminations (1)

SD941-1

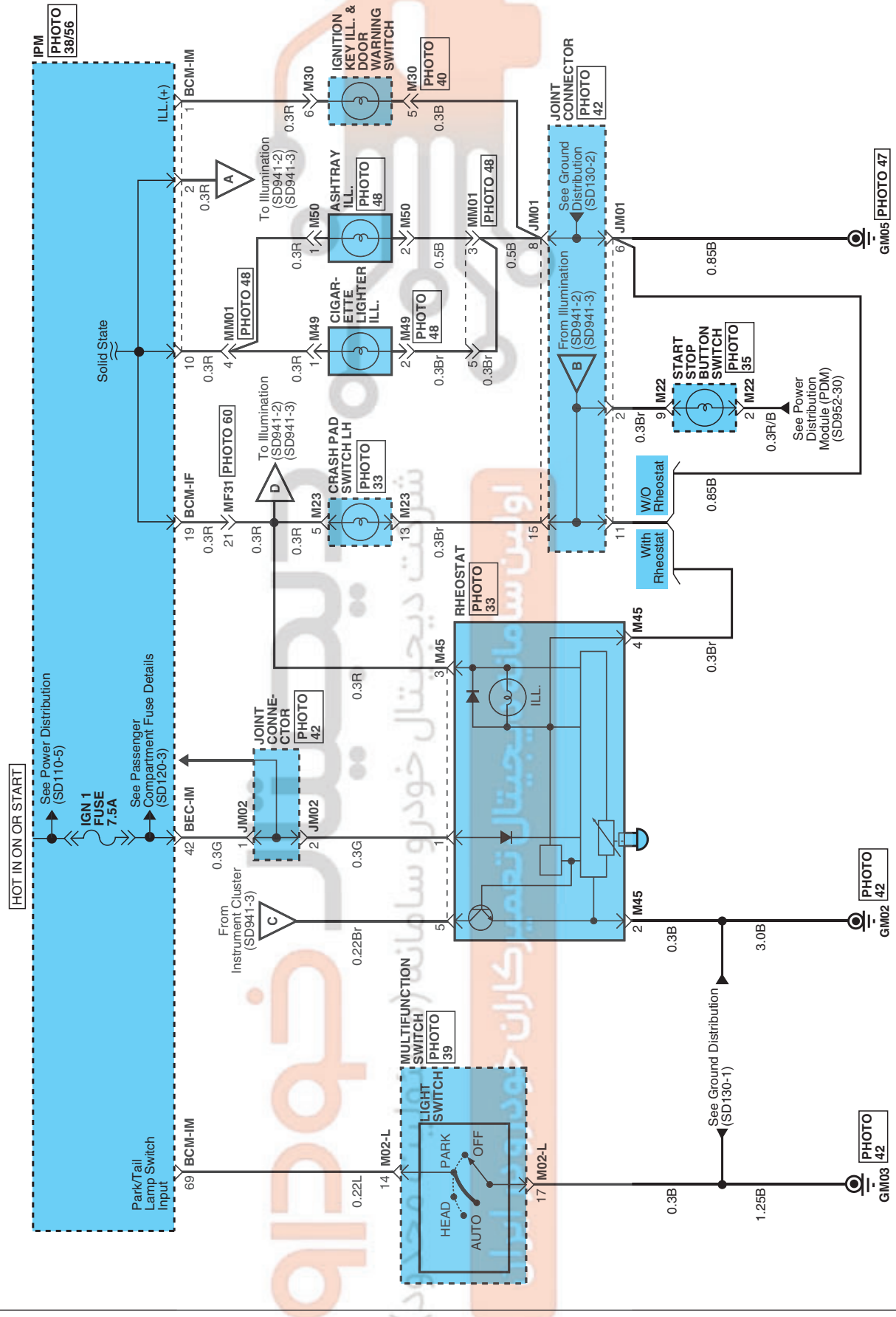

ILLUMINATIONS

Illuminations (2)

SD941-2

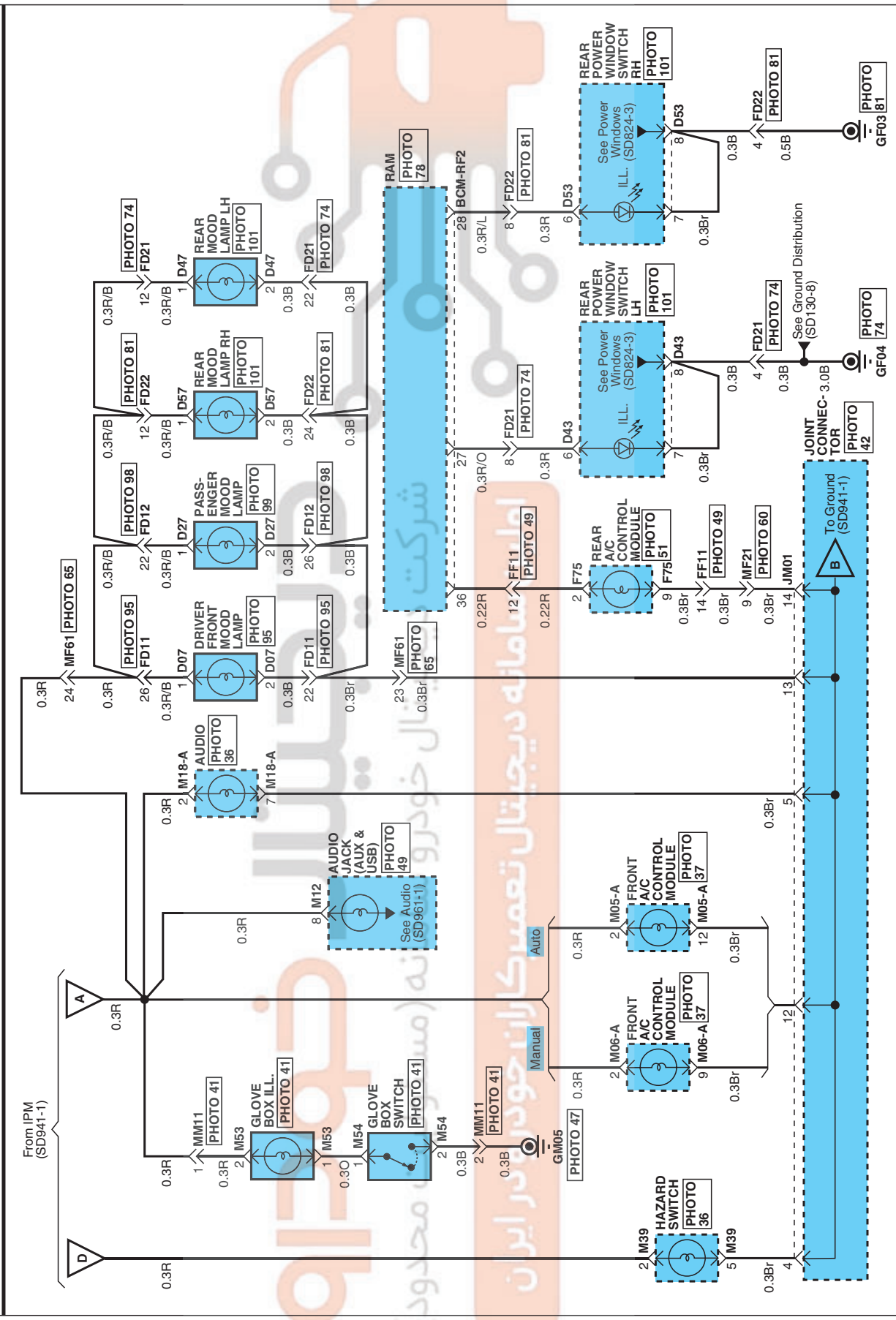

ILLUMINATIONS

Illuminations (3)

SD941-3

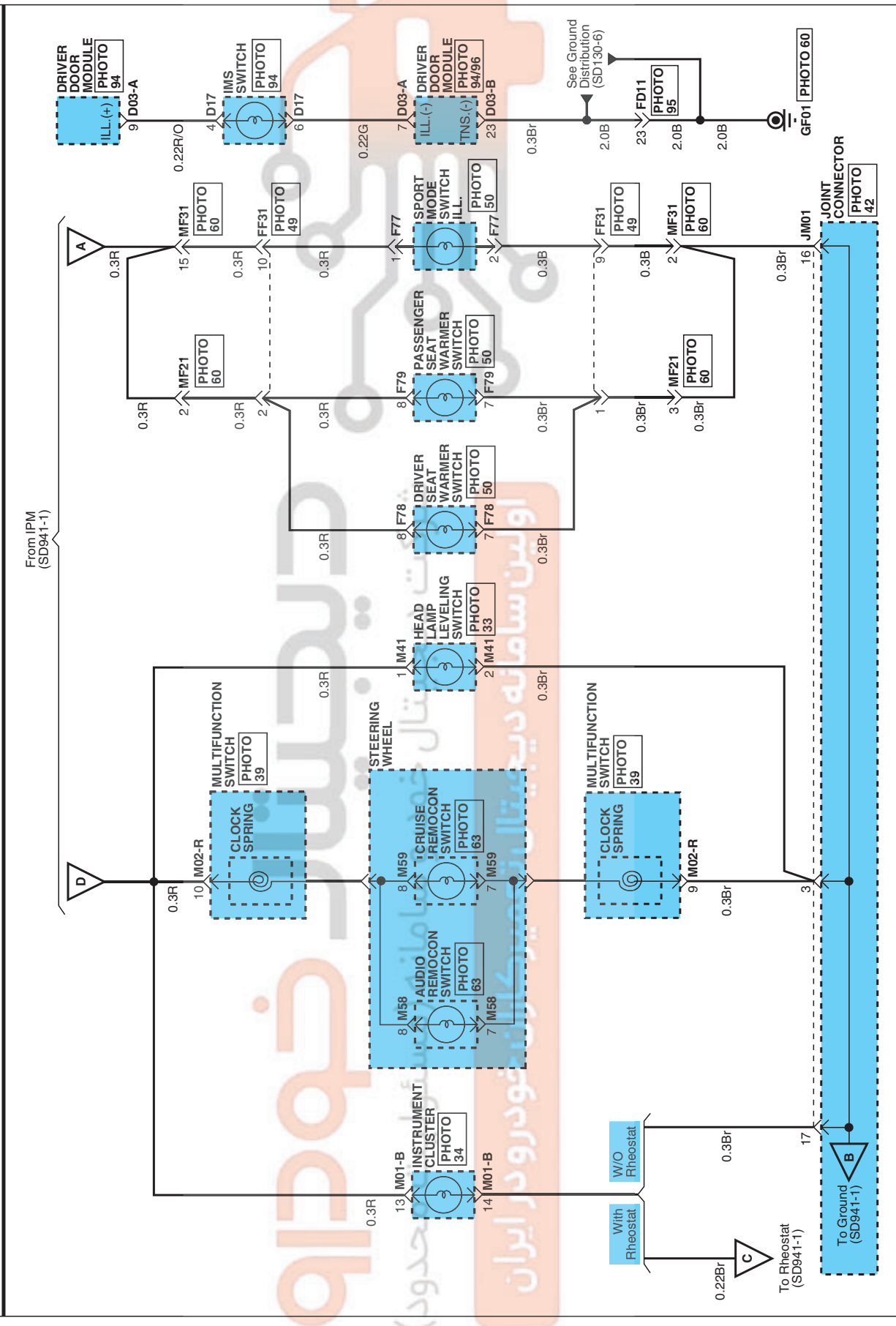

ILLUMINATIONS

Illuminations (4)



SD941-4

<p>D03-A</p> <p>KET_050_10F_W</p>	<p>D03-B</p> <p>KET_050_23F_W</p>	<p>D07</p> <p>KET_090II_02F_B_R</p>	<p>D17</p> <p>AMP_025_08F_W</p>
<p>D23-A</p> <p>KET_050_23F_W</p>	<p>D27</p> <p>KET_090II_02F_B_R</p>	<p>D43</p> <p>KET_090III_08F_B</p>	<p>D47</p> <p>KET_090II_02F_B_R</p>
<p>D53</p> <p>KET_090III_08F_B</p>	<p>D57</p> <p>KET_090II_02F_B_R</p>	<p>F75</p> <p>AMP_040M2_20F_B</p>	<p>F77</p> <p>KUM_CDR_02F_W</p>
<p>F78</p> <p>AMP_MOS_08F_B</p>	<p>F79</p> <p>AMP_MOS_08F_B</p>	<p>M01-B</p> <p>AMP_040M1_16F_B</p>	<p>M02-L</p> <p>KET_0509_18F_B</p>
<p>M02-R</p> <p>AMP_025_12F_W</p>	<p>M05-A</p> <p>AMP_0407_26F_W</p>	<p>M06-A</p> <p>KET_050_23F_W</p>	<p>M06-A</p> <p>KET_050_23F_W</p>

ILLUMINATIONS

Illuminations (5)

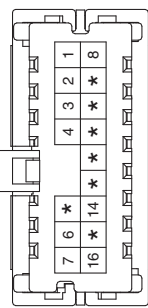
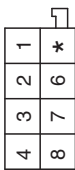
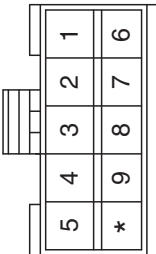
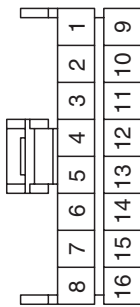
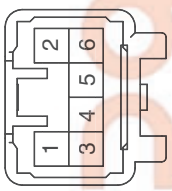
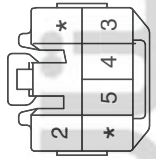
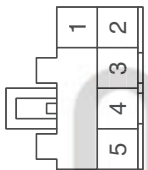
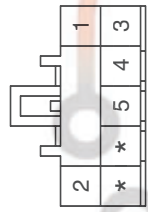
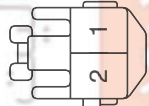
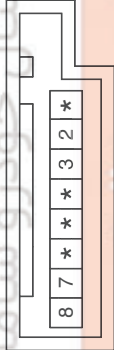
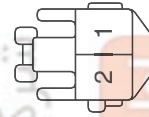
SD941-5

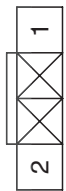
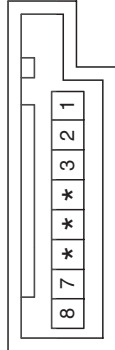
<p>M12</p>  <p>KET_040IIL_16F_BR</p>	<p>M18-A</p>  <p>AMP_AUDIO_08F_Gr_D2</p>	<p>M22</p>  <p>MLX_025_10F_B</p>	<p>M23</p>  <p>AMP_040M1_16F_B</p>
<p>M30</p>  <p>KET_090IIL_06M_W</p>	<p>M39</p>  <p>KET_090IL_06F_W</p>	<p>M41</p>  <p>KUM_CDR_09F_W</p>	<p>M45</p>  <p>KUM_CDR_07F_L</p>
<p>M49</p>  <p>KET_090IL_02F_B_R</p>	<p>M58</p>  <p>AMP_1743284-1</p>	<p>M50</p>  <p>KET_090IL_02F_B_R</p>	<p>M53</p>  <p>AMP_PLM1_02F_B</p>
<p>M54</p>  <p>KET_187_02F_W</p>	<p>M59</p>  <p>AMP_1743284-2</p>	<p>BLANK</p>	<p>BLANK</p>

ILLUMINATIONS

Illuminations (6)

SD941-6

MEMO

دیجیتال خودرو

شرکت دیجیتال خودرو سامانه (مسئولیت محدود)

اولین سامانه دیجیتال تعمیرکاران خودرو در ایران

