

Combination Meter <LHD>

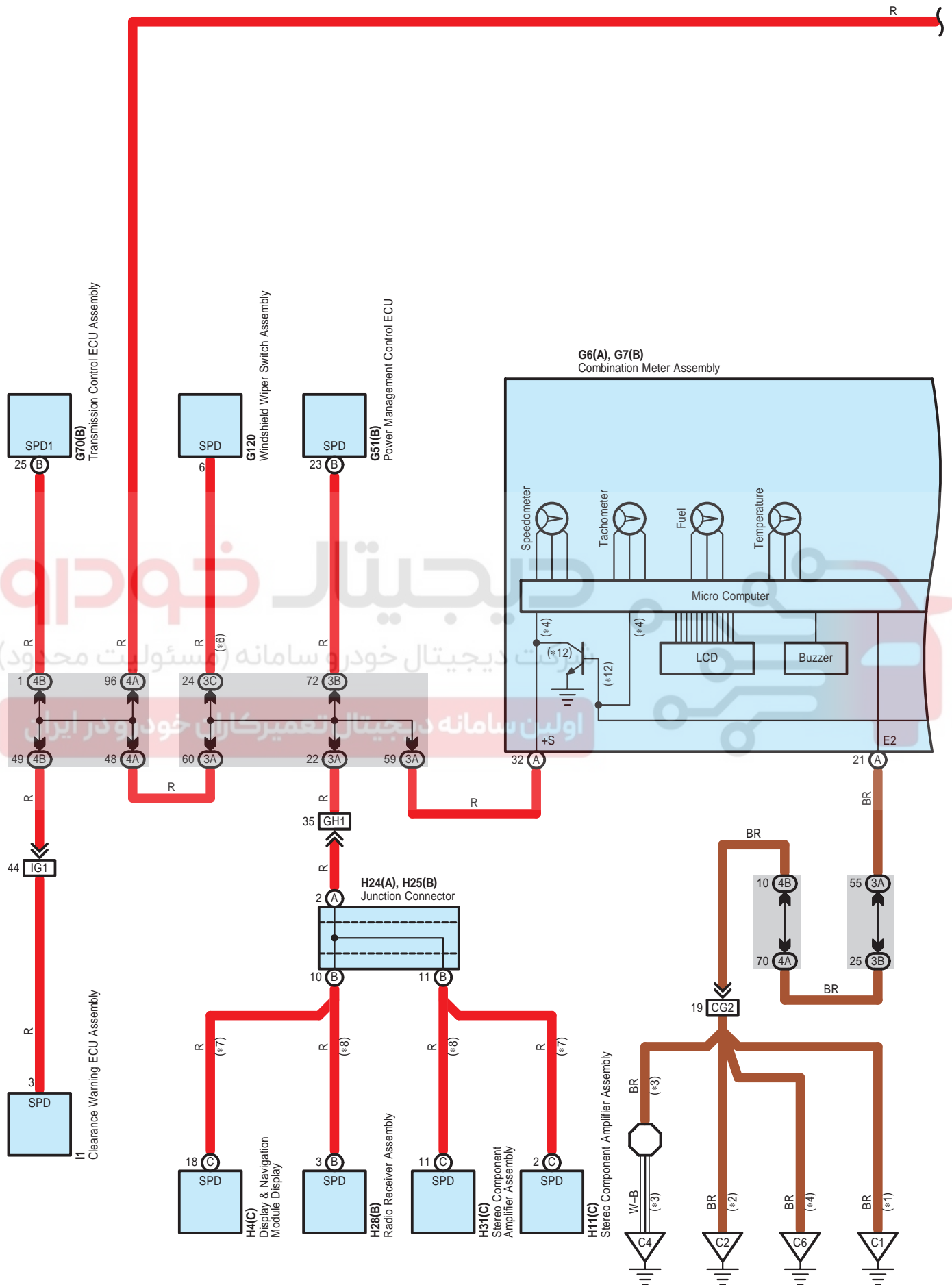

Combination Meter <LHD>

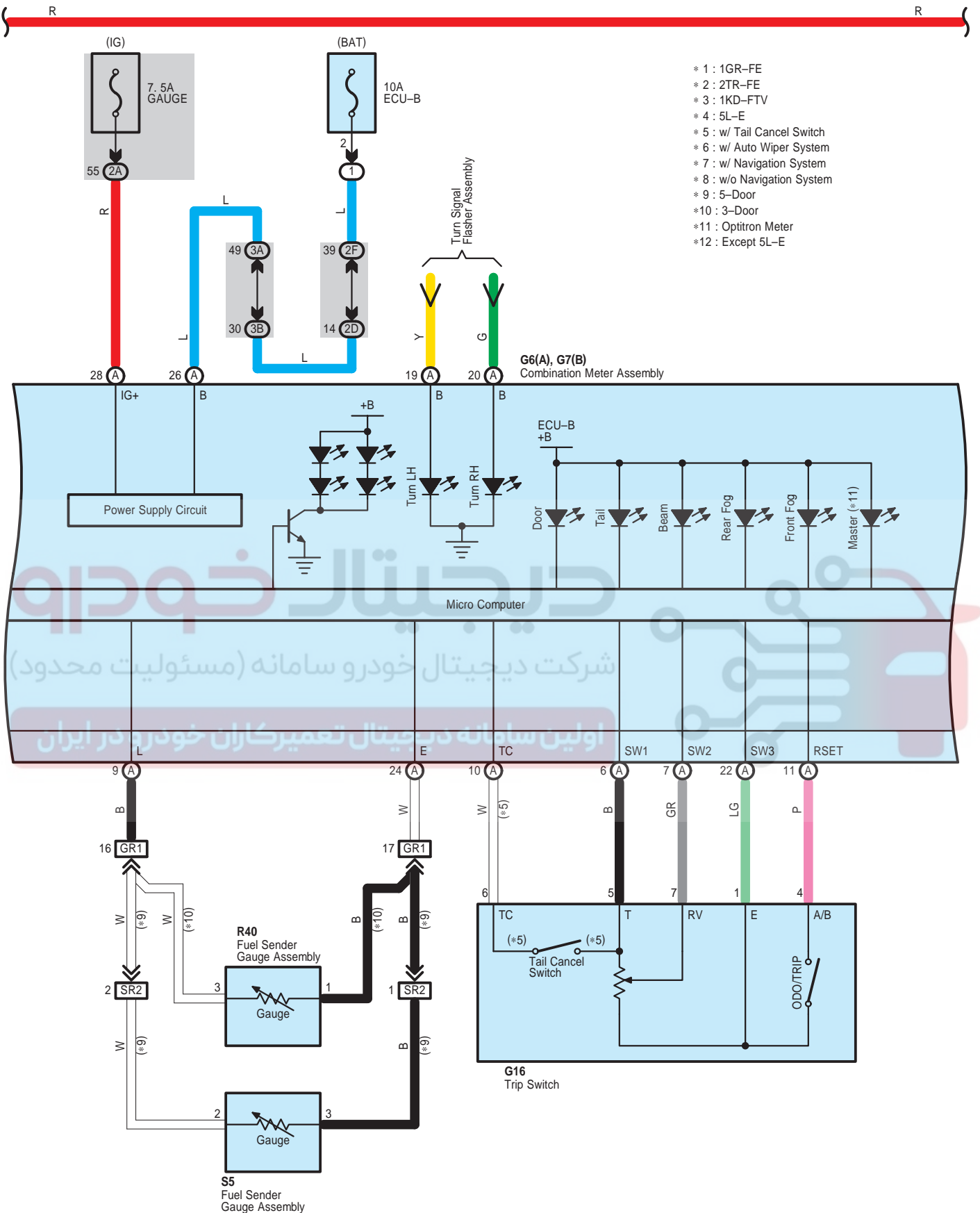

Combination Meter <LHD>



G6(A), G7(B)
Combination Meter Assembly

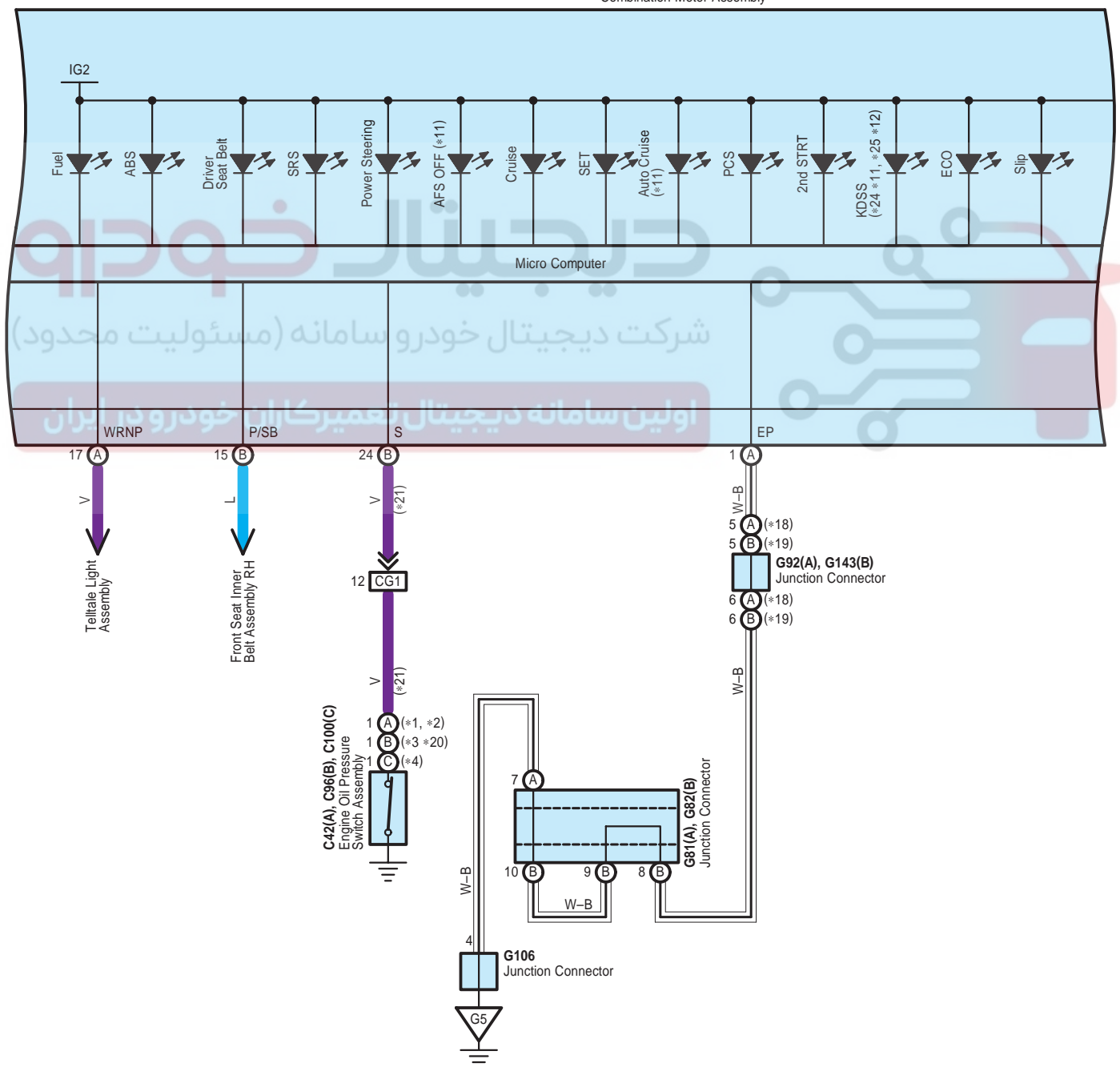

Combination Meter <LHD>

- * 1 : 1GR-FE
- * 2 : 2TR-FE
- * 3 : 1KD-FTV
- * 4 : 5L-E
- * 11 : Optitron Meter
- * 12 : Except 5L-E
- * 14 : Except Optitron Meter
- * 15 : 5-Door w/ Fuel Sub Tank
- * 16 : 3-Door Metallic Fuel Tank
- * 17 : *15, *16
- * 18 : Before Oct. 2010 Production
- * 19 : From Oct. 2010 Production
- * 20 : w/o DPF
- * 21 : Except 1KD-FTV w/ DPF
- * 24 : Before Oct. 2011 Production
- * 25 : From Oct. 2011 Production

G6(A), G7(B)
Combination Meter Assembly

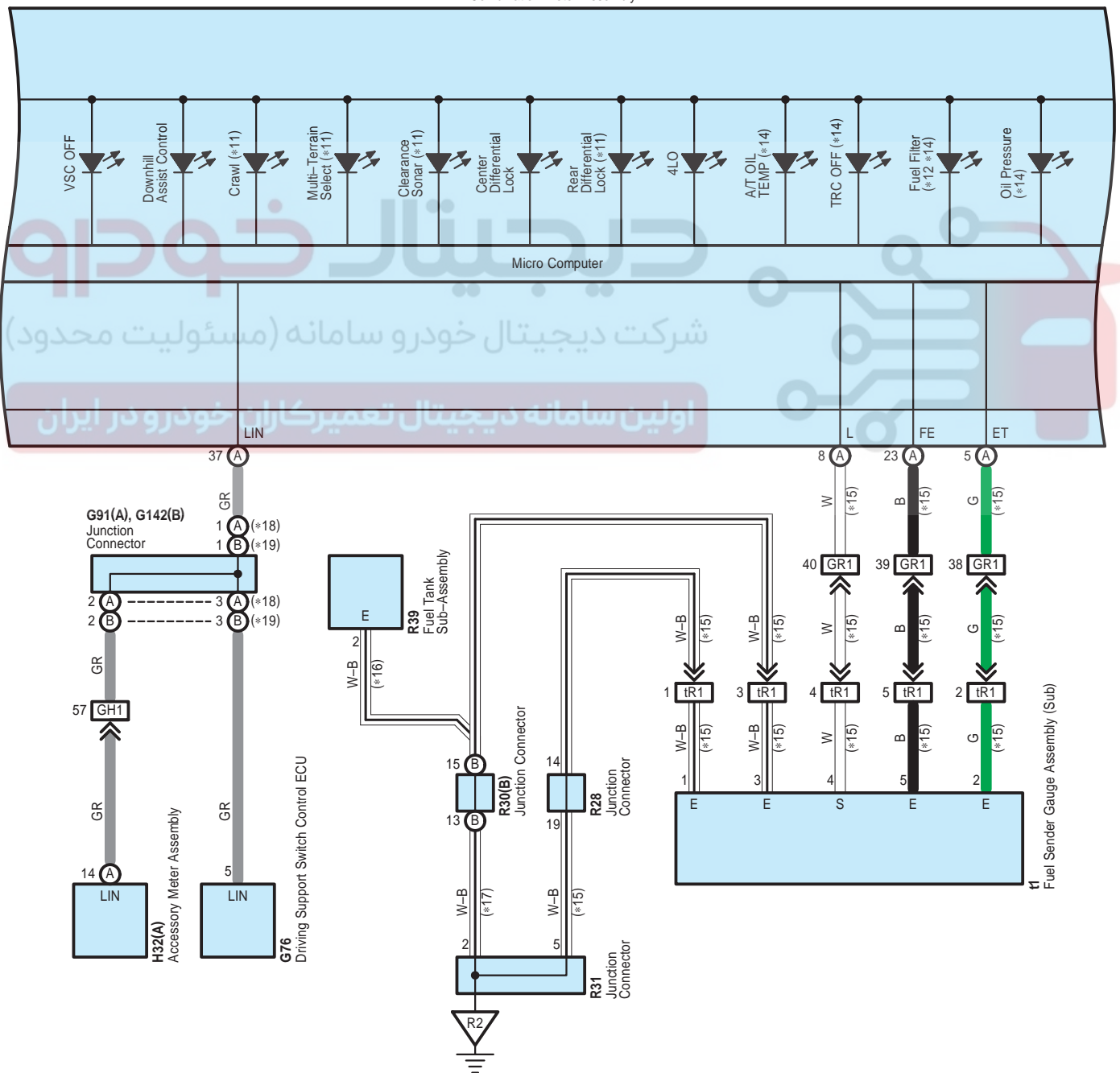

Combination Meter <LHD>



- * 1 : 1GR-FE
- * 2 : 2TR-FE
- * 3 : 1KD-FTV
- * 4 : 5L-E
- *10 : 3-Door
- *13 : Diesel
- *14 : Except Optitron Meter
- *18 : Before Oct. 2010 Production
- *19 : From Oct. 2010 Production
- *22 : For production through approximately Jan. 2011
- *23 : For production from approximately Jan. 2011
- *25 : From Oct. 2011 Production

G6(A), G7(B)
Combination Meter Assembly

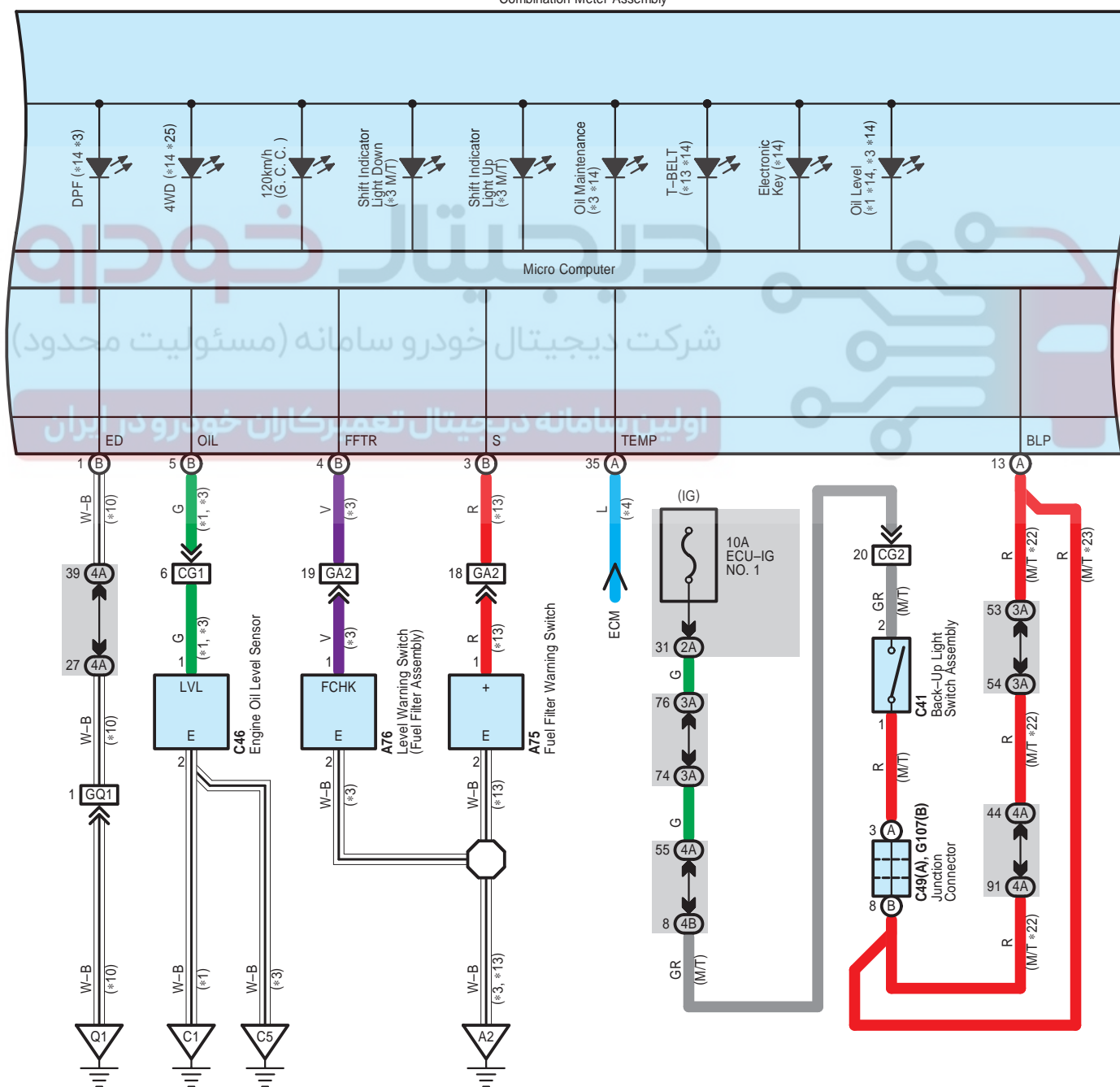

Combination Meter <LHD>

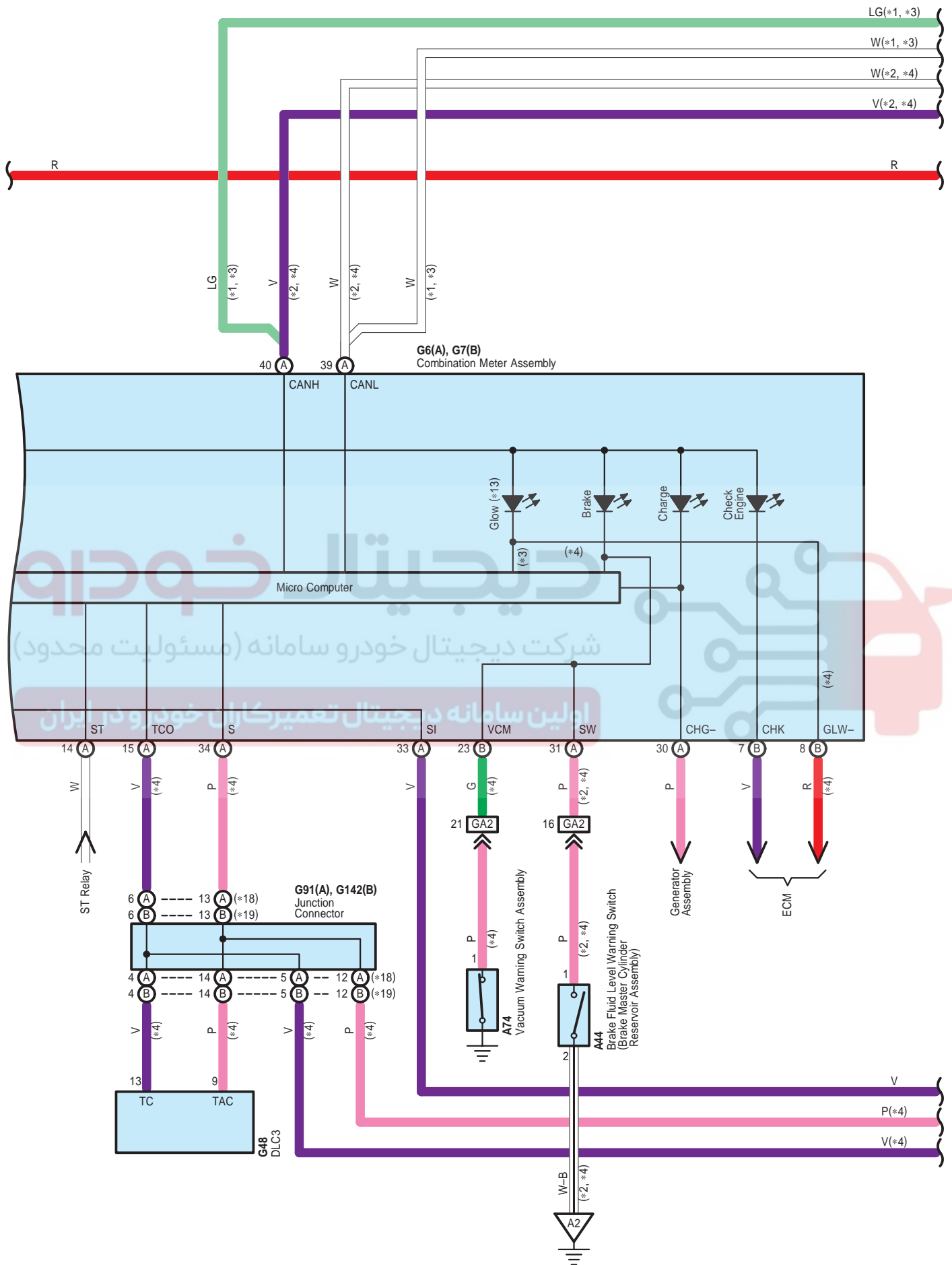

Combination Meter <LHD>

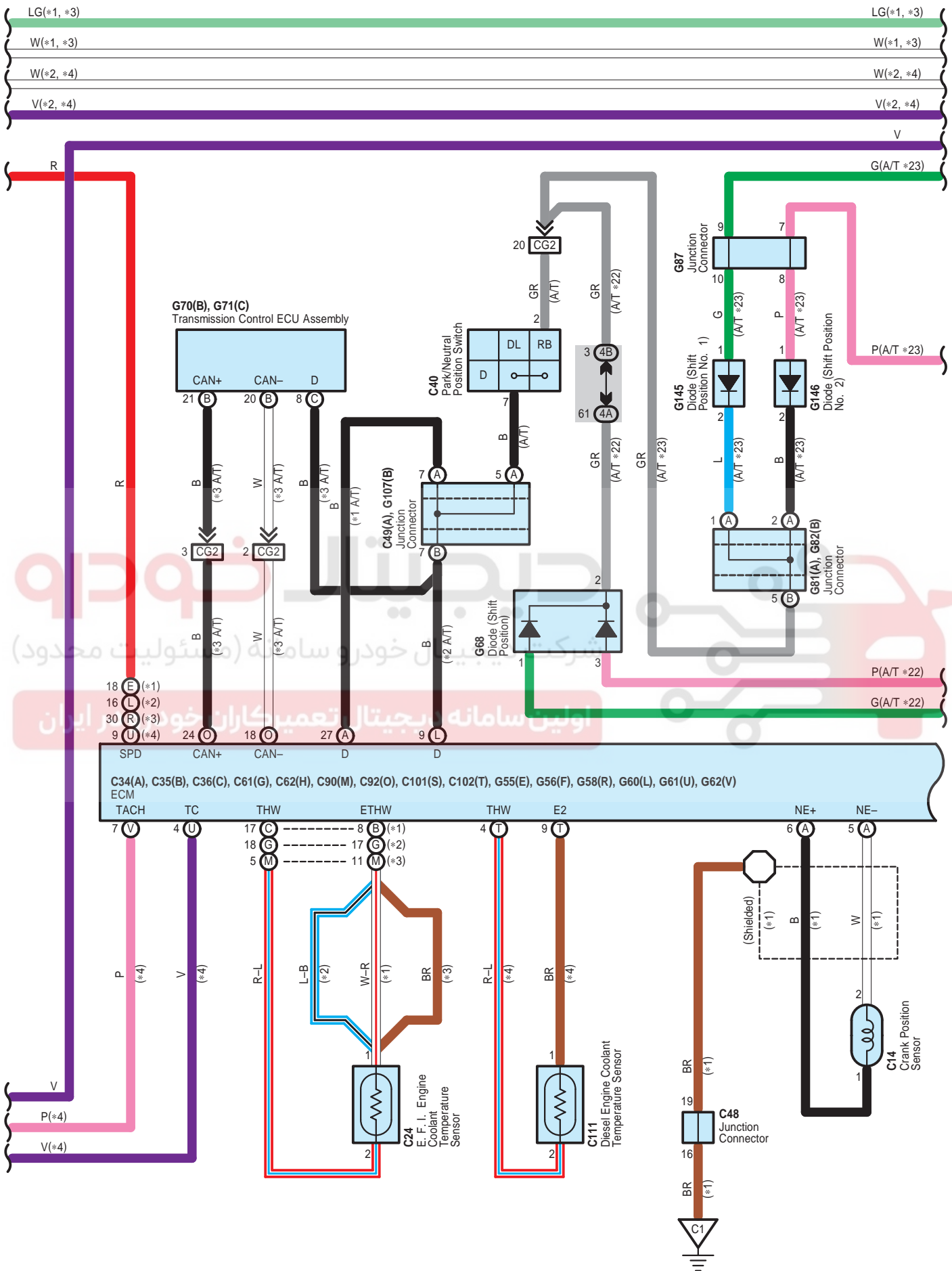

Combination Meter <LHD>

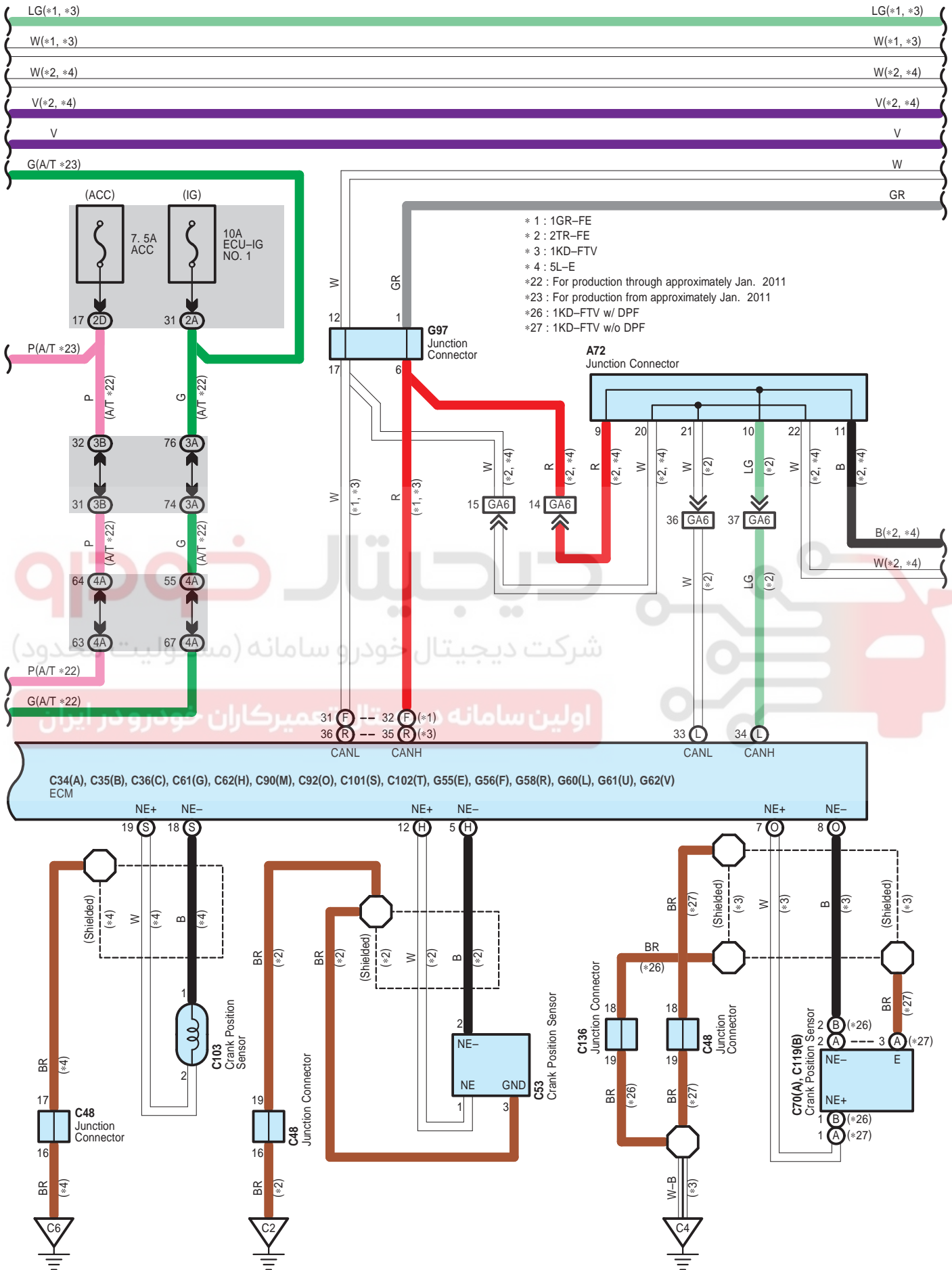

Combination Meter <LHD>

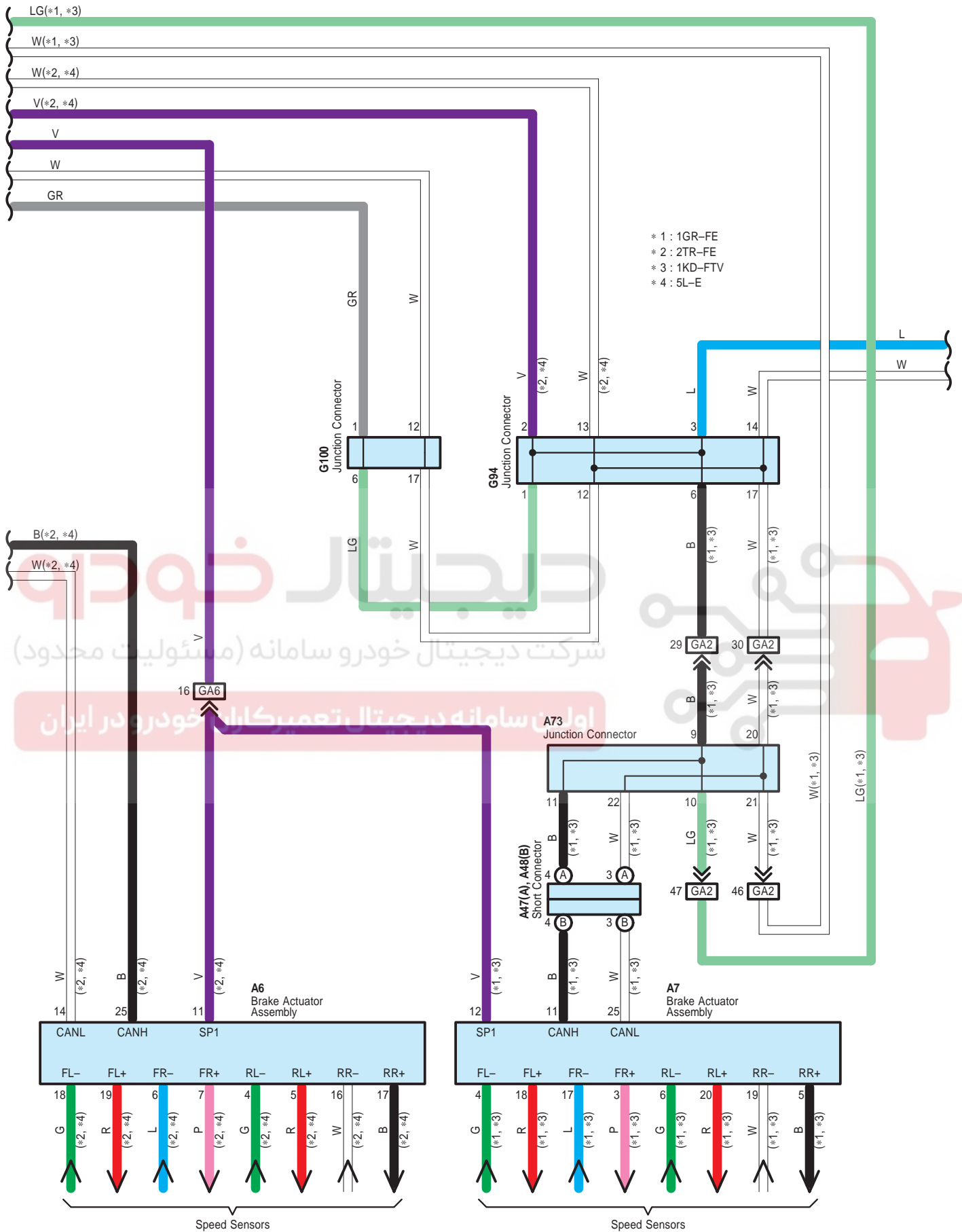

Combination Meter <LHD>

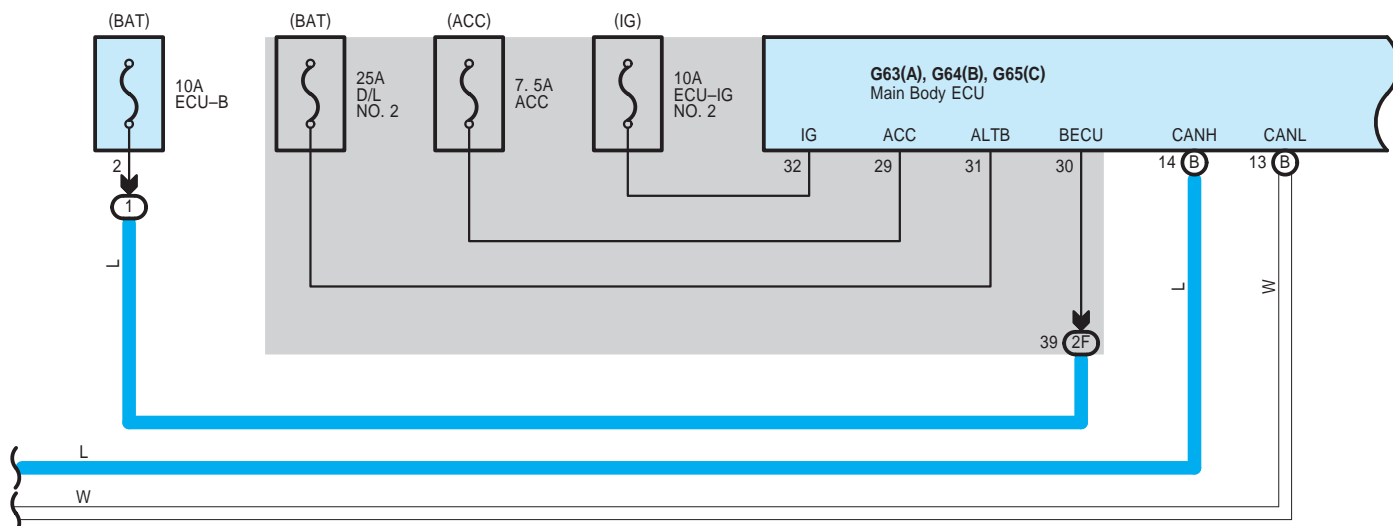

دیجیتال خودرو

شرکت دیجیتال خودرو سامانه (مسئولیت محدود)

اولین سامانه دیجیتال تعمیرکاران خودرو در ایران



Combination Meter <LHD>

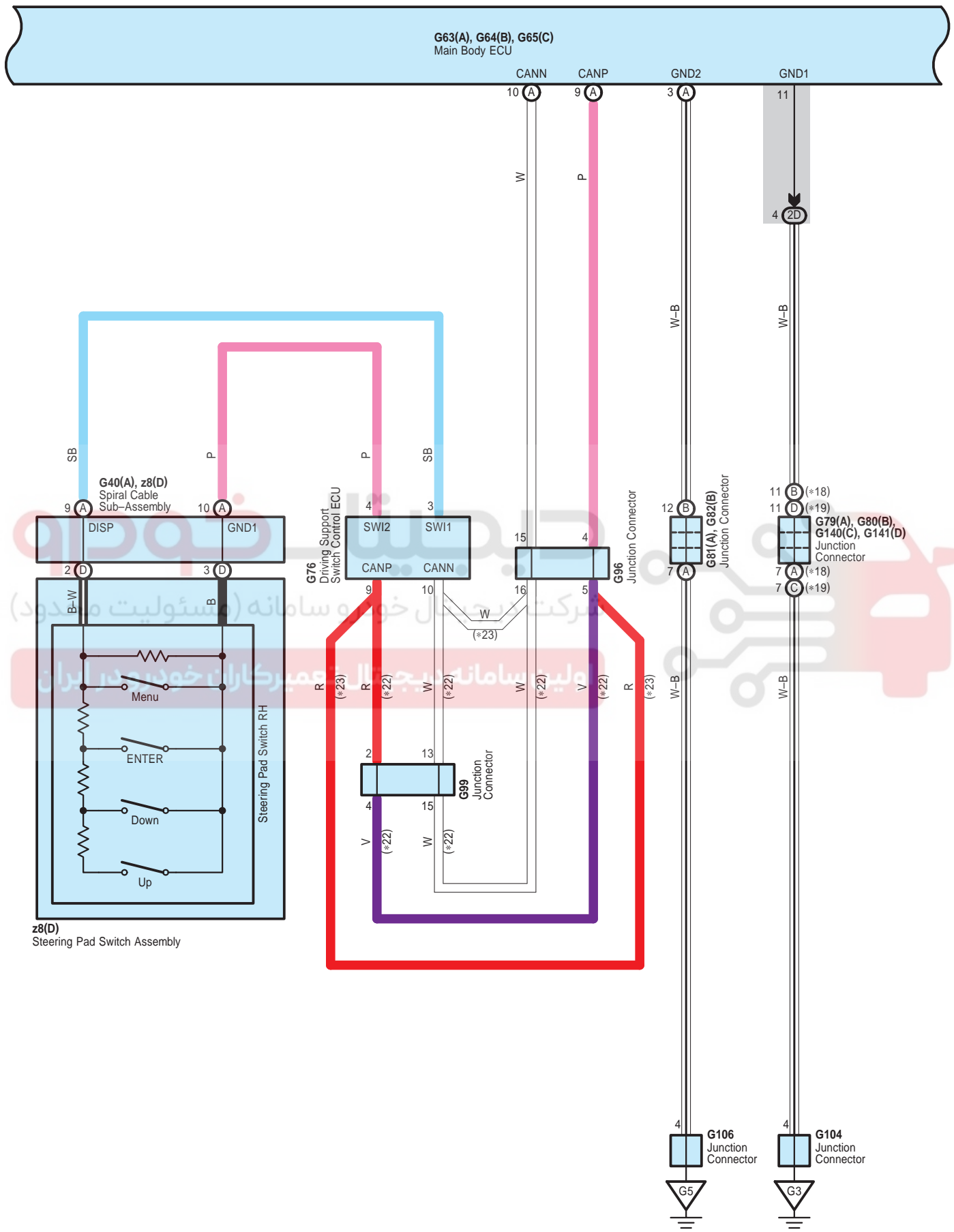

Combination Meter <LHD>

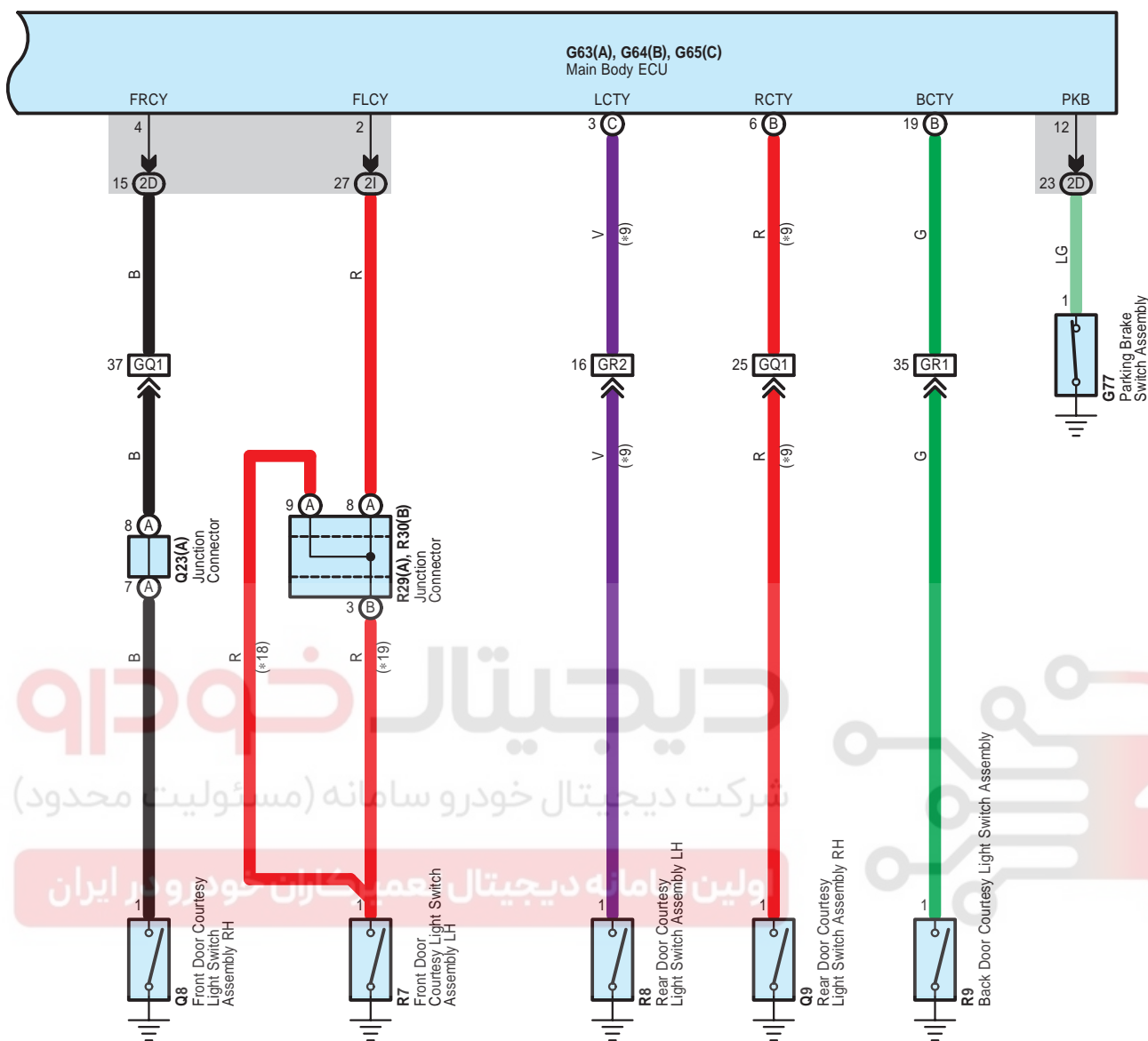

* 9 : 5-Door
 * 18 : Before Oct. 2010 Production
 * 19 : From Oct. 2010 Production
 * 22 : For production through approximately Jan. 2011
 * 23 : For production from approximately Jan. 2011

Combination Meter <LHD>

A 6
Black

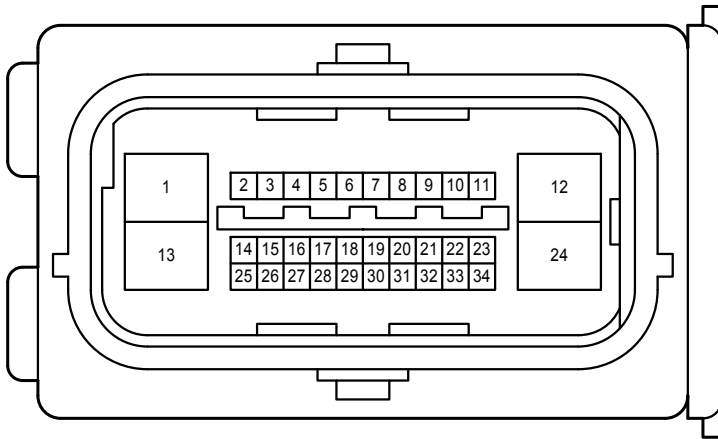

A 7
Black

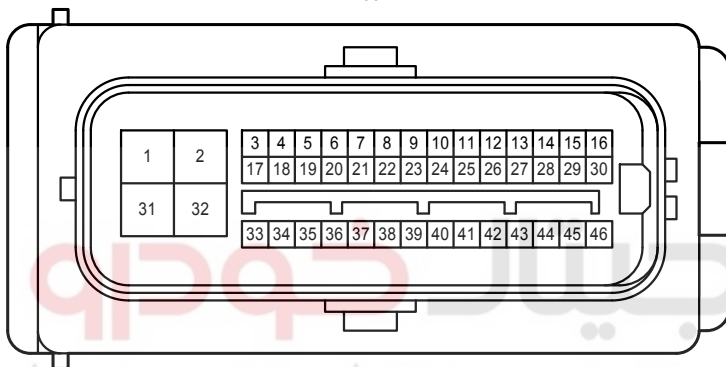

A 44
Gray



A 47
Gray



A 48
Gray



A 72
White

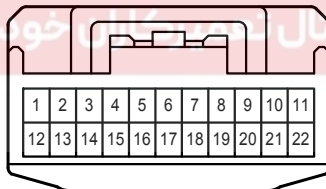

A 73
White

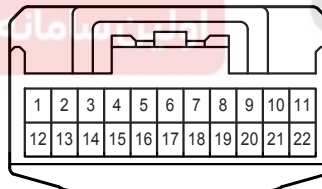

A 74
Gray



A 75
Gray



A 76
Black

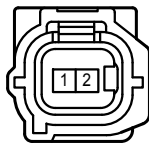

C 14
Black

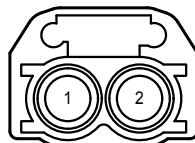

C 24
Black



C 34
White

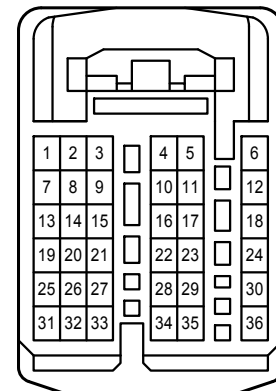

Combination Meter <LHD>

C 35

White

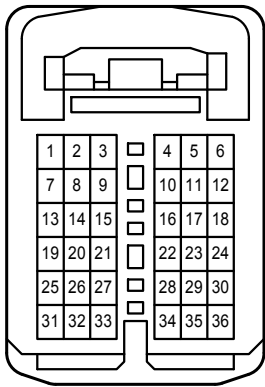

C 36

White

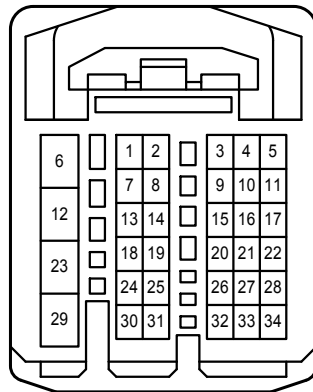

C 40

Gray

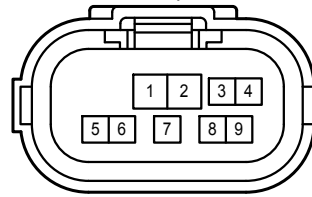

C 41

Gray

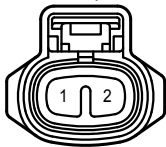

C 42

Gray



C 46

Gray



C 48

White

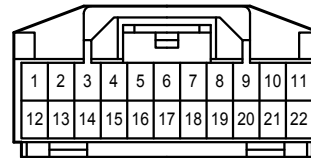

C 49

Blue

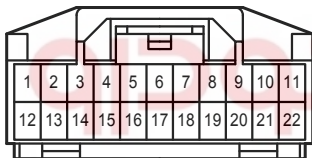

C 53

Dark Gray



C 61

White

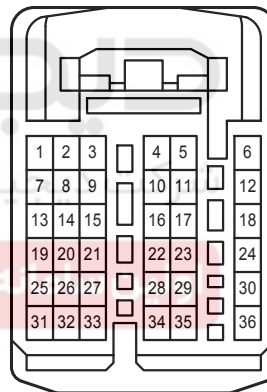

C 62

White

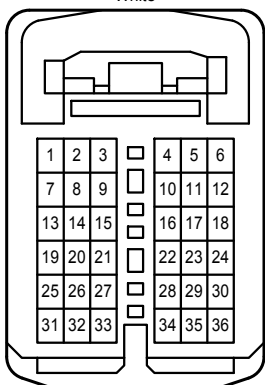

C 70

Gray



C 90

White

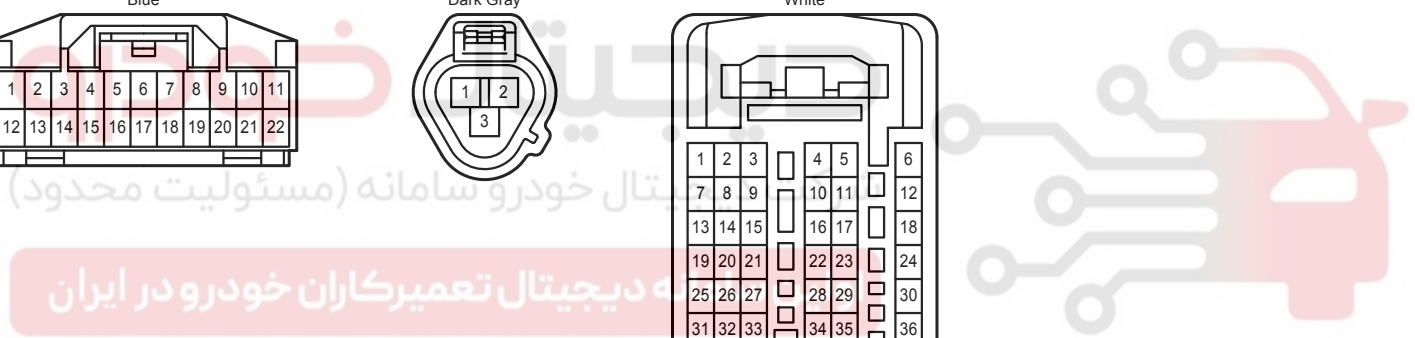
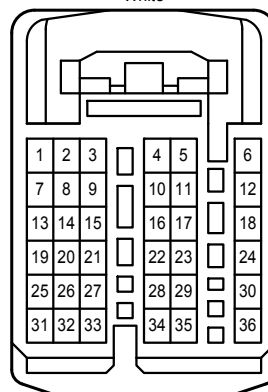

Combination Meter <LHD>

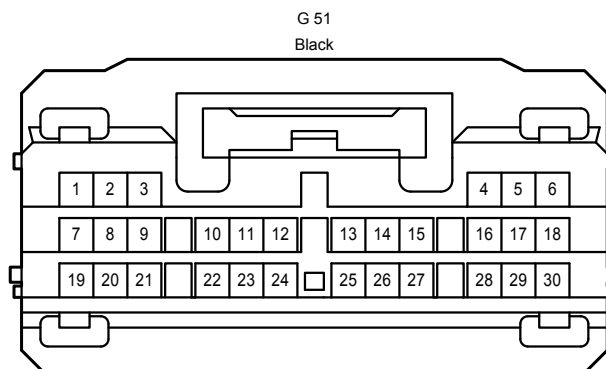
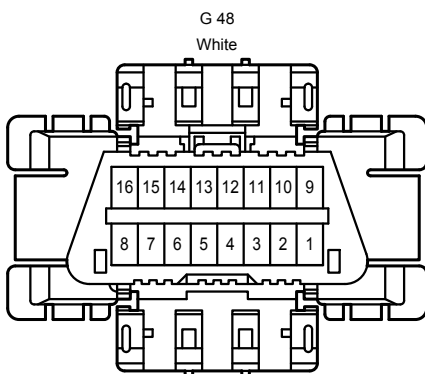
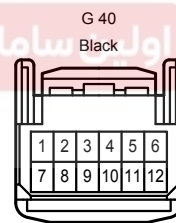
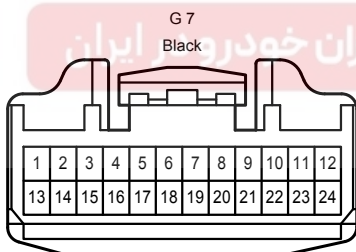
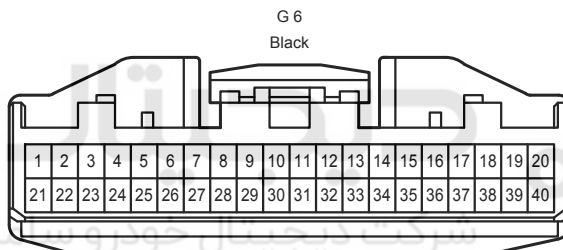
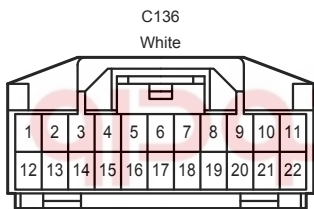
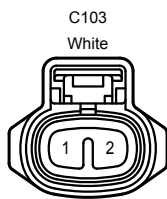
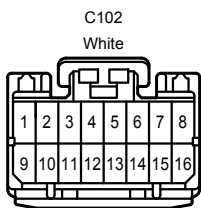
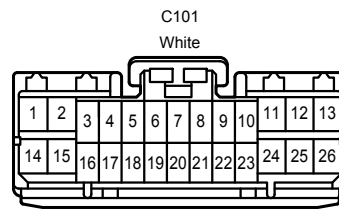
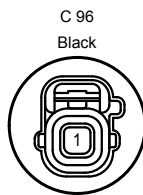
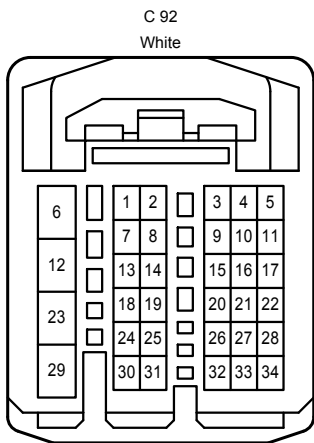

Combination Meter <LHD>

G 55
White

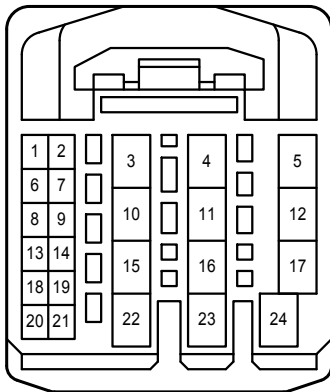

G 56
White

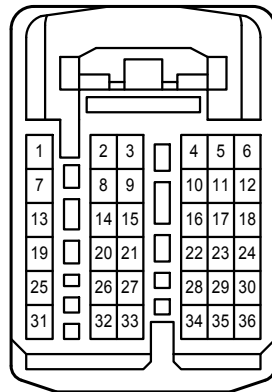

G 58
White

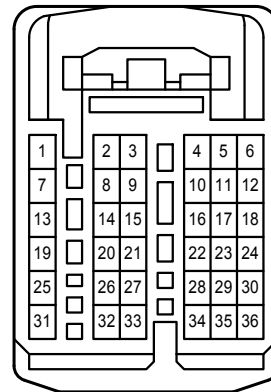

G 60
White

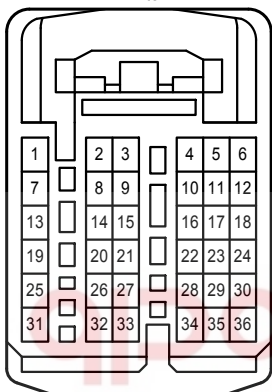

G 61
White

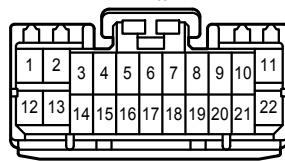

G 62
White

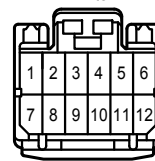

G 63
White

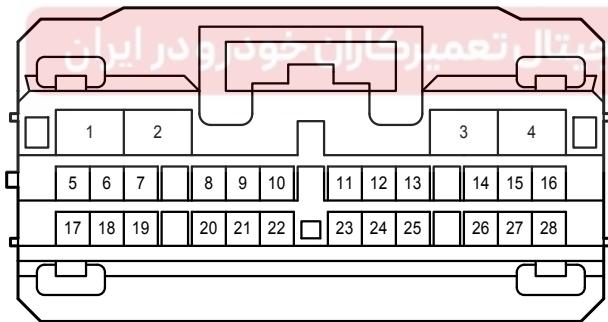

G 64
White

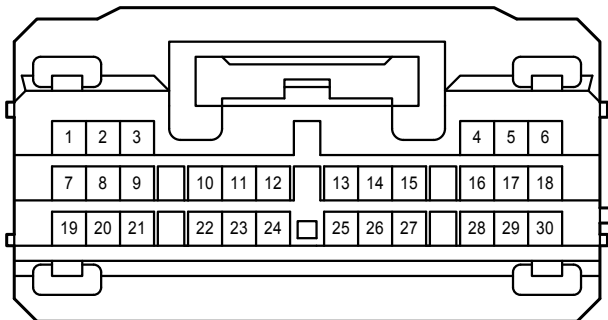

G 65
White

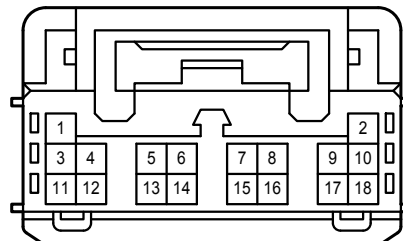

دیجیتال خودرو
شرکت دیجیتال خودرو سامانه (مسئولیت محدود)
اولین سامانه دیجیتال تعمیرکاران خودرو در ایران



Combination Meter <LHD>

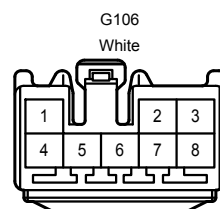
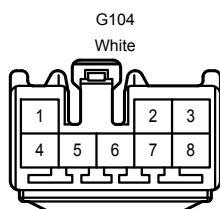
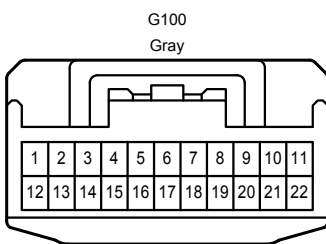
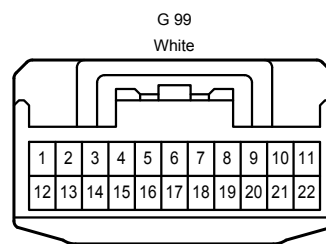
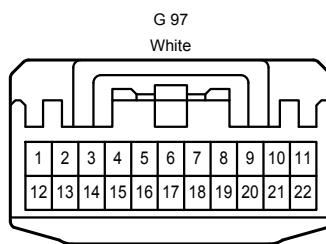
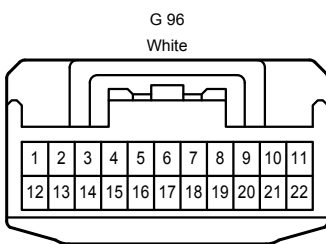
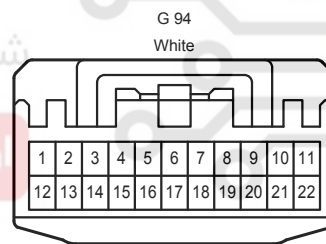
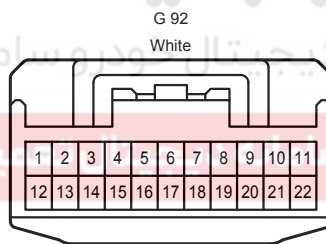
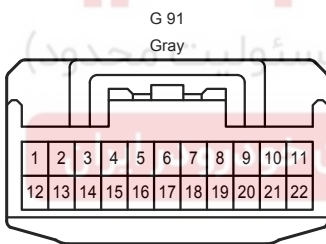
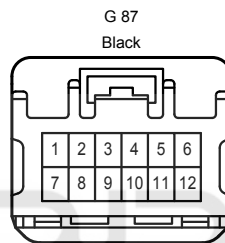
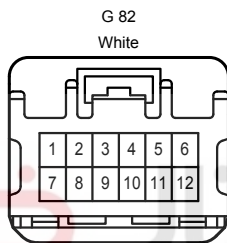
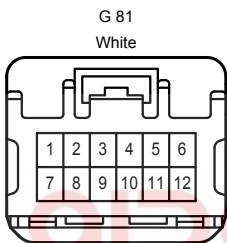
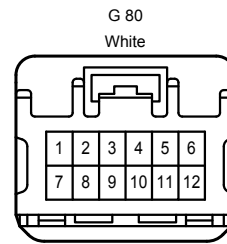
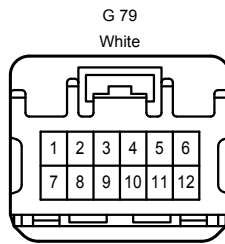
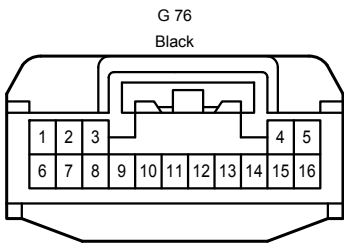
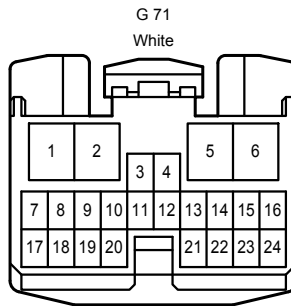
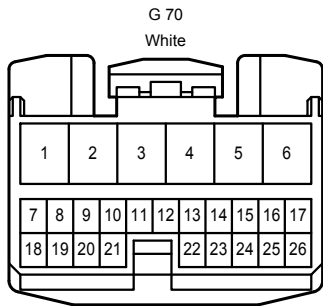
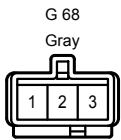

Combination Meter <LHD>

G107
Blue

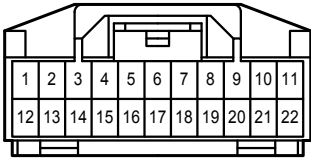

G120
White

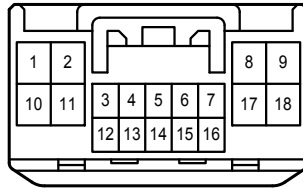

G140
Black

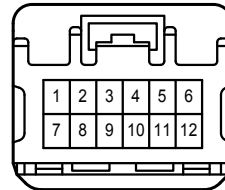

G141
Black

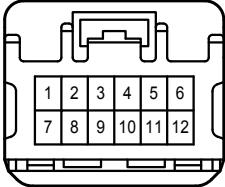

G142
White

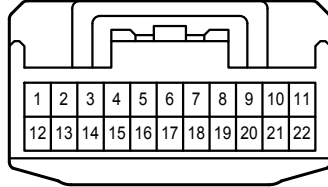

G143
Black

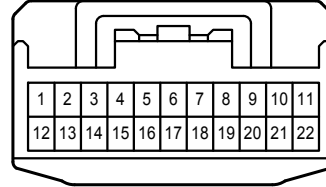

G145
Gray



G146
Gray



H 4
White

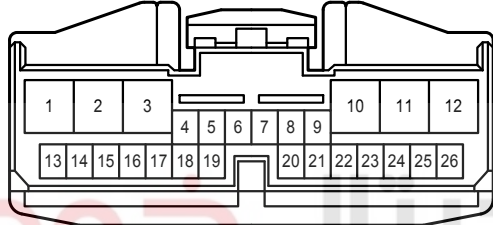

H 11
White

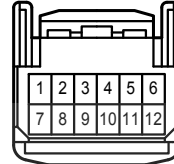

H 24
White

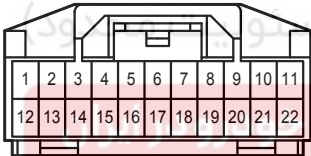

H 25
White

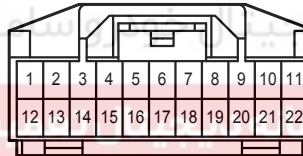

H 28
White

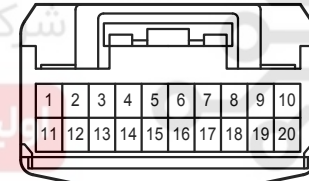

H 31
White

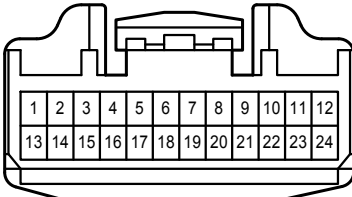

H 32
White

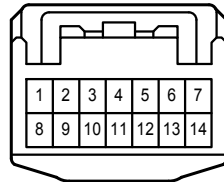

I 1
White

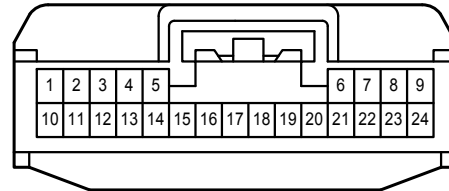

Q 8
Black



Q 9
White



Q 23
White

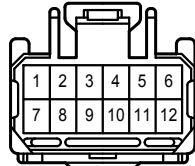

R 7
Black



R 8
White



R 9
Black



Combination Meter <LHD>

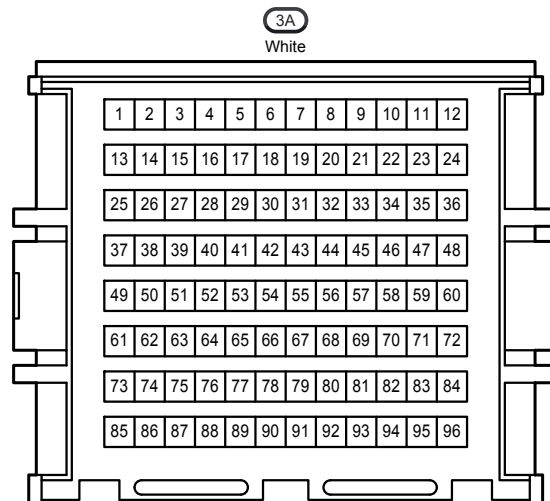
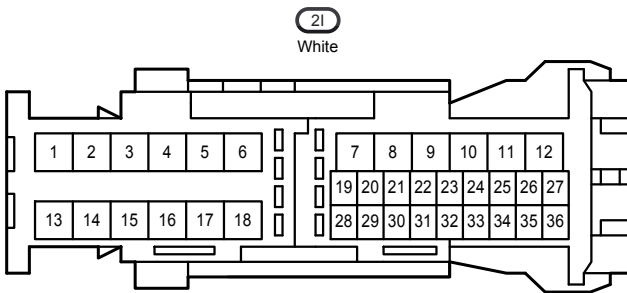
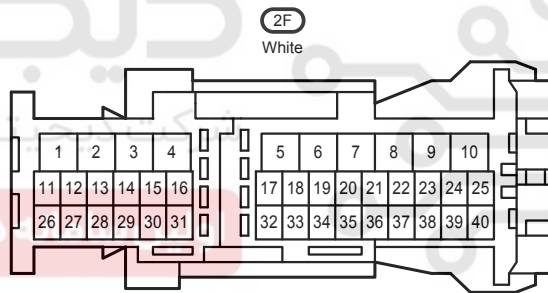
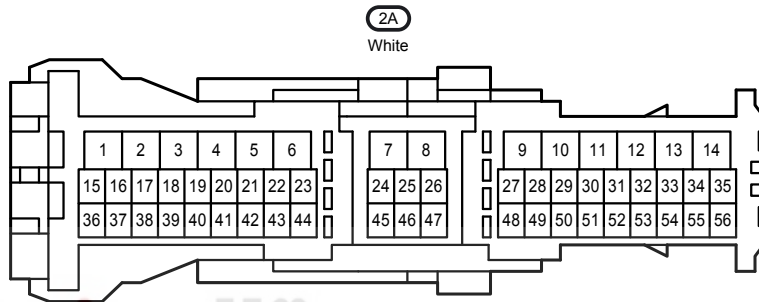
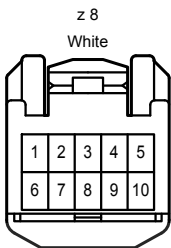
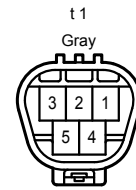
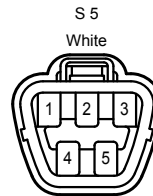
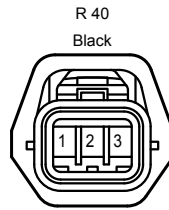
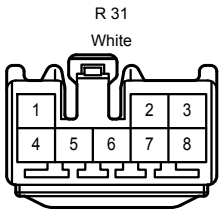
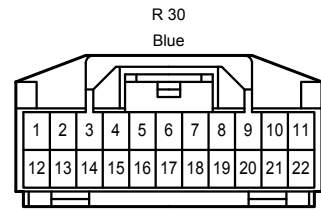
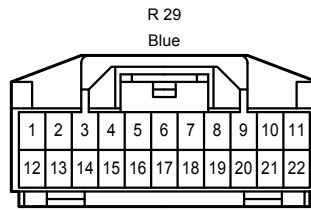
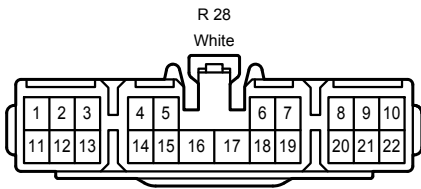

Combination Meter <LHD>

3B
White

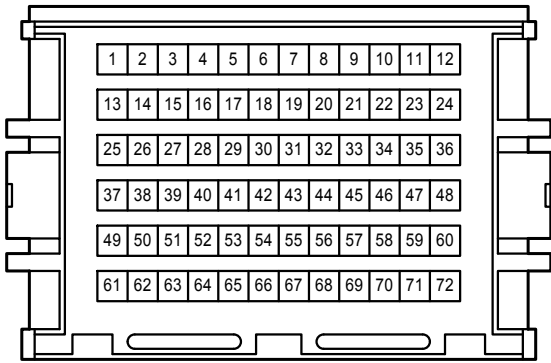

3C
White

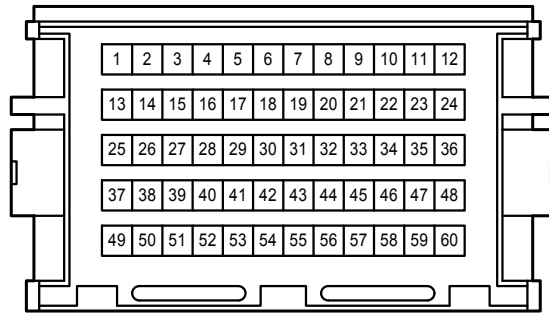

4A
White

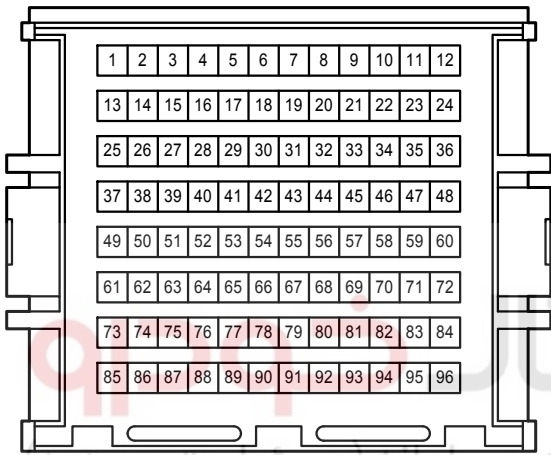

4B
White

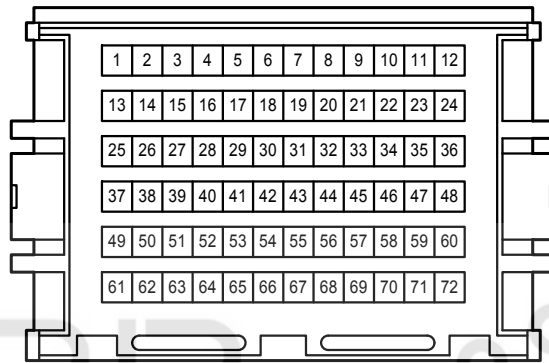

CG1
White

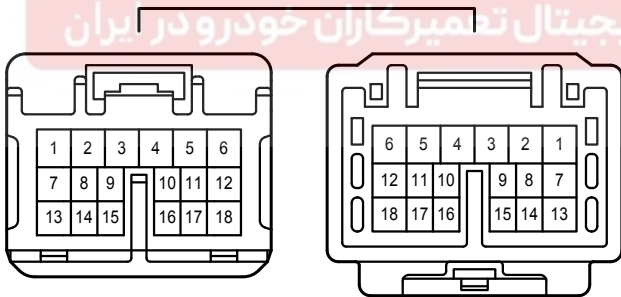

CG2
White

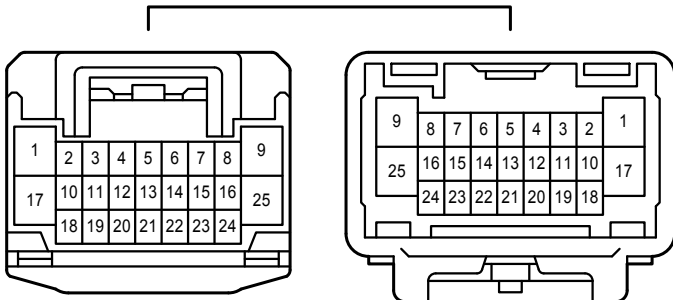

Combination Meter <LHD>

GA2
White

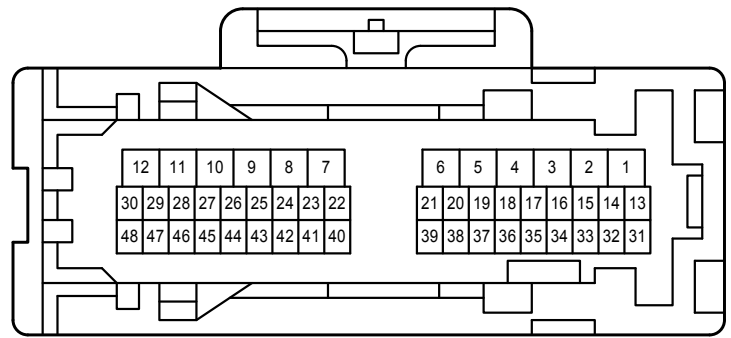
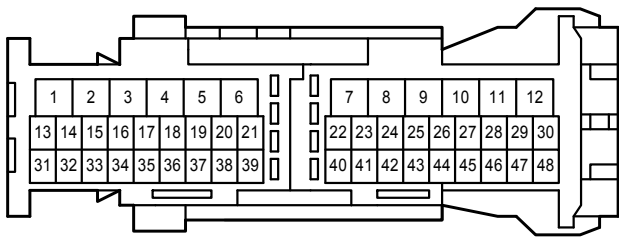

GA6
White

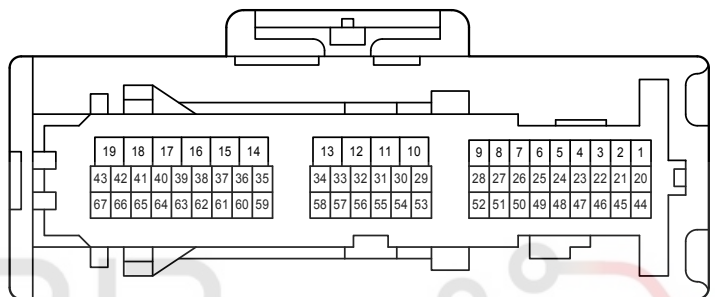
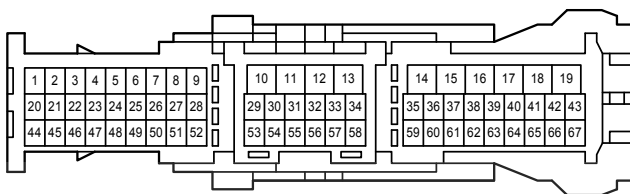

GH1
White

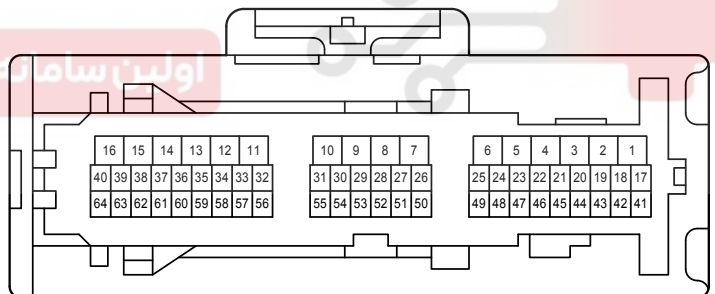
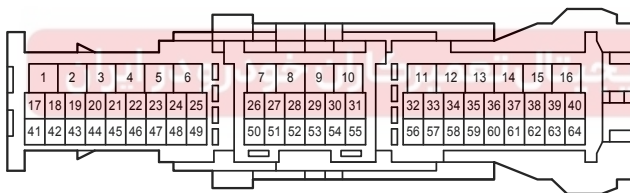

GQ1
White

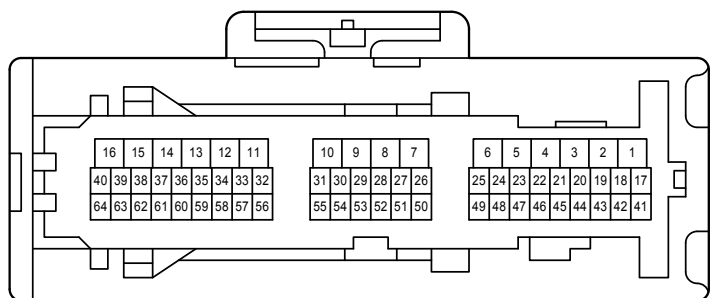
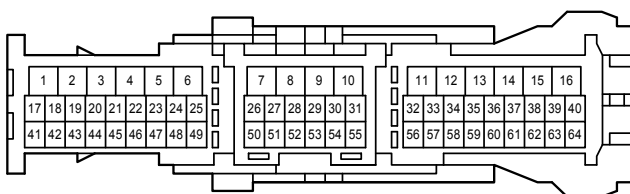

Combination Meter <LHD>

GR1
White

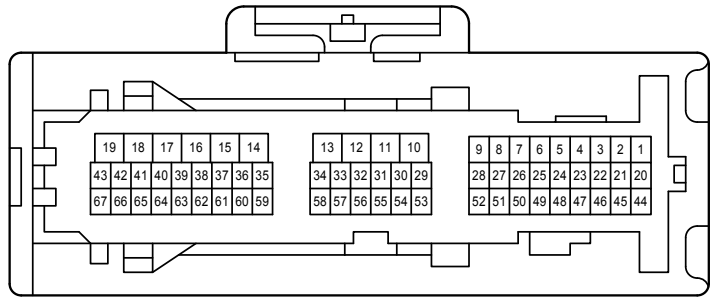
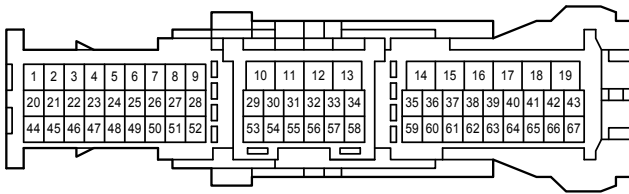

GR2
Gray

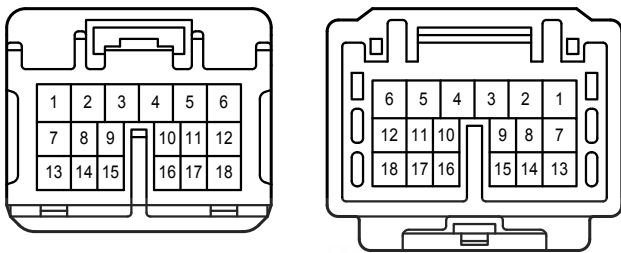

IG1
White

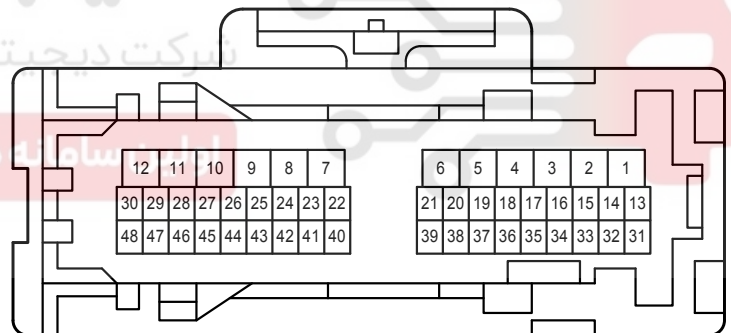
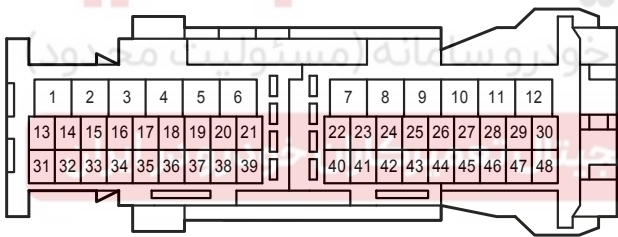

SR2
White

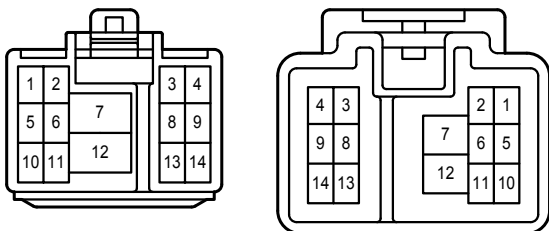

tR1
Gray

