

12. MANUAL AIR CONDITIONING SYSTEM

1) CONDENSER FAN MOTOR, A/C COMPRESSOR, TRIPLE PRESSURE SWITCH, A/C TEMPERATURE SWITCH

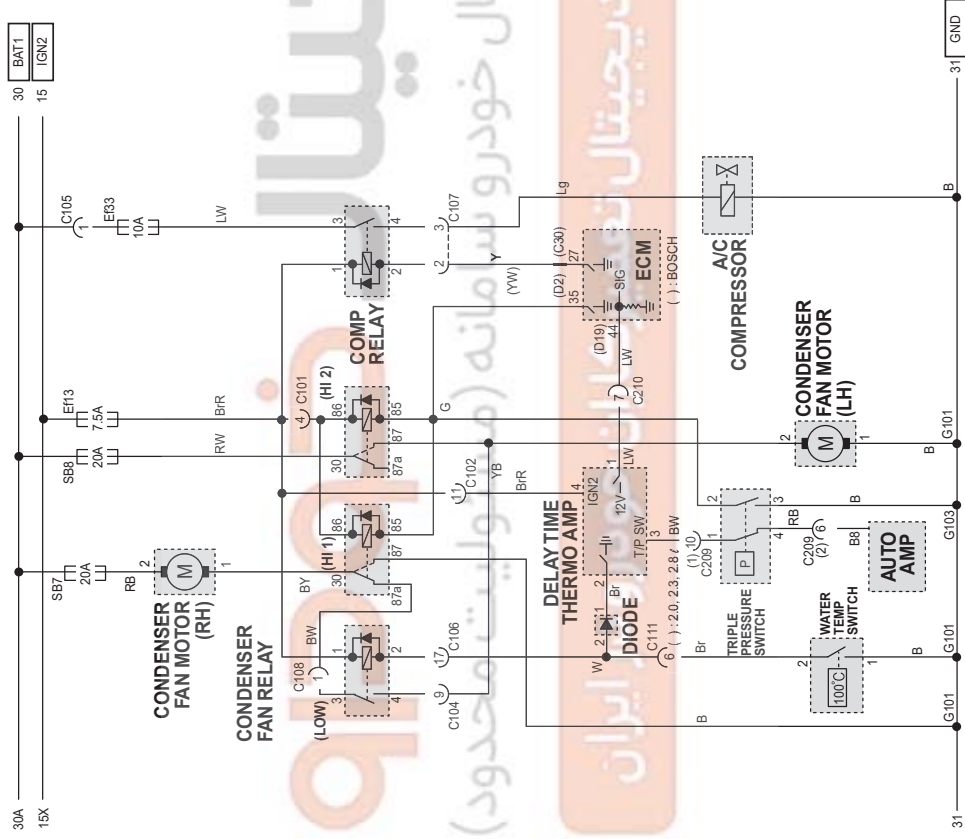

a. CONNECTOR INFORMATION

CONNECTOR NUMBER	WIRING HARNESS	GROUND POSITION
G101	Engine Room	Behind Left Head Lamp
G103	Engine Room	Behind Right Head Lamp

b. CONNECTOR IDENTIFICATION SYMBOL & PIN NUMBER POSITION

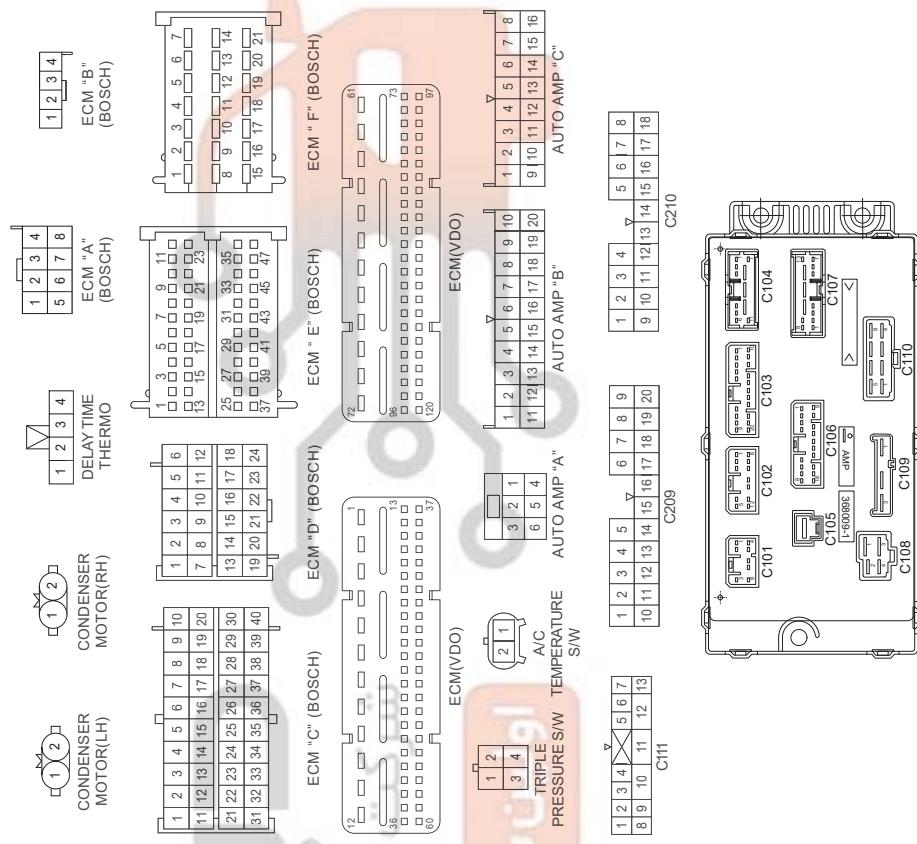

C. POSITION OF CONNECTORS AND GROUNDS

- W/H ENGINE ROOM

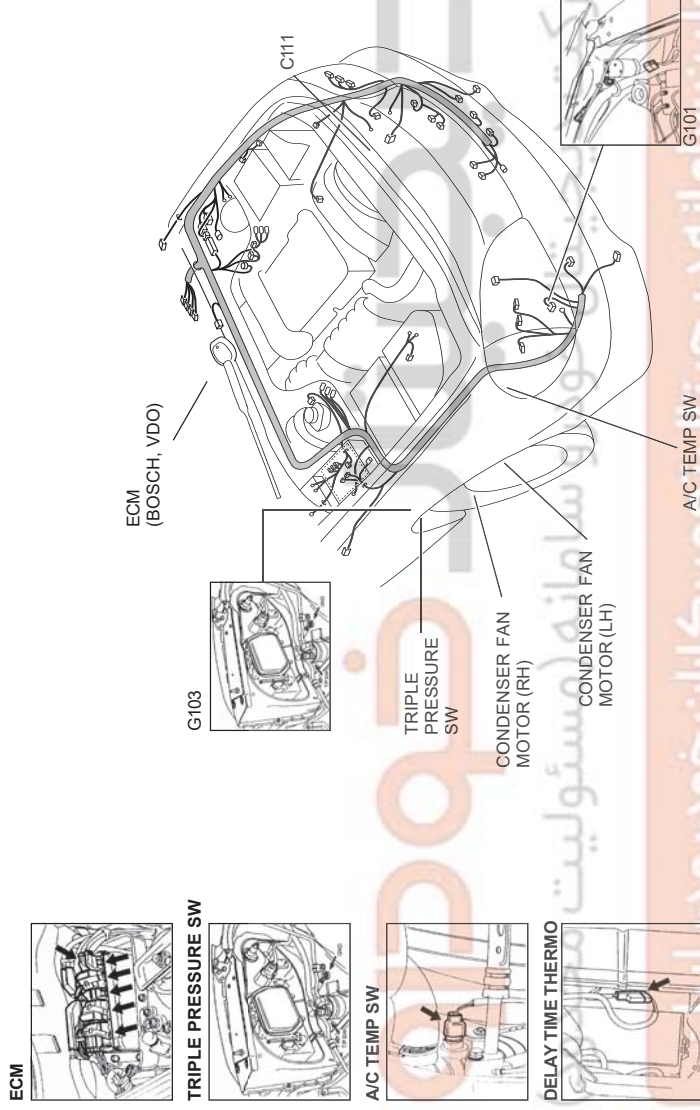

- W/H MAIN : FRONT

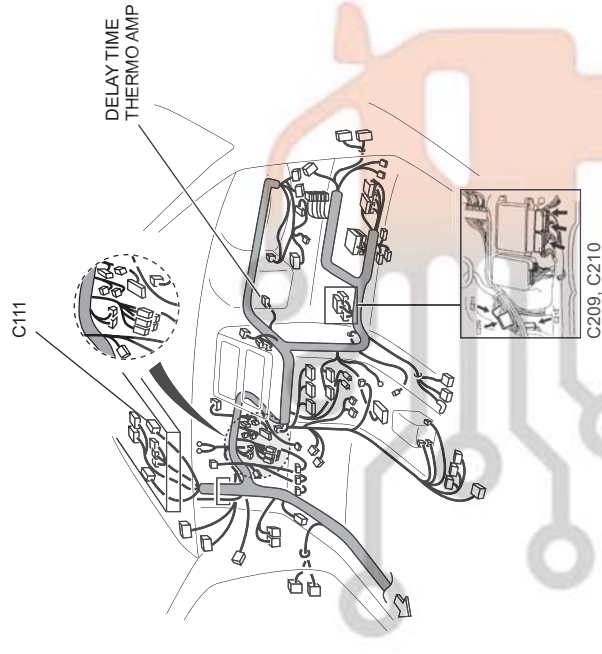

2) ACTUATOR (MIX, MODE, INTAKE), BLOWER (MOTOR, RESISTOR, SWITCH)

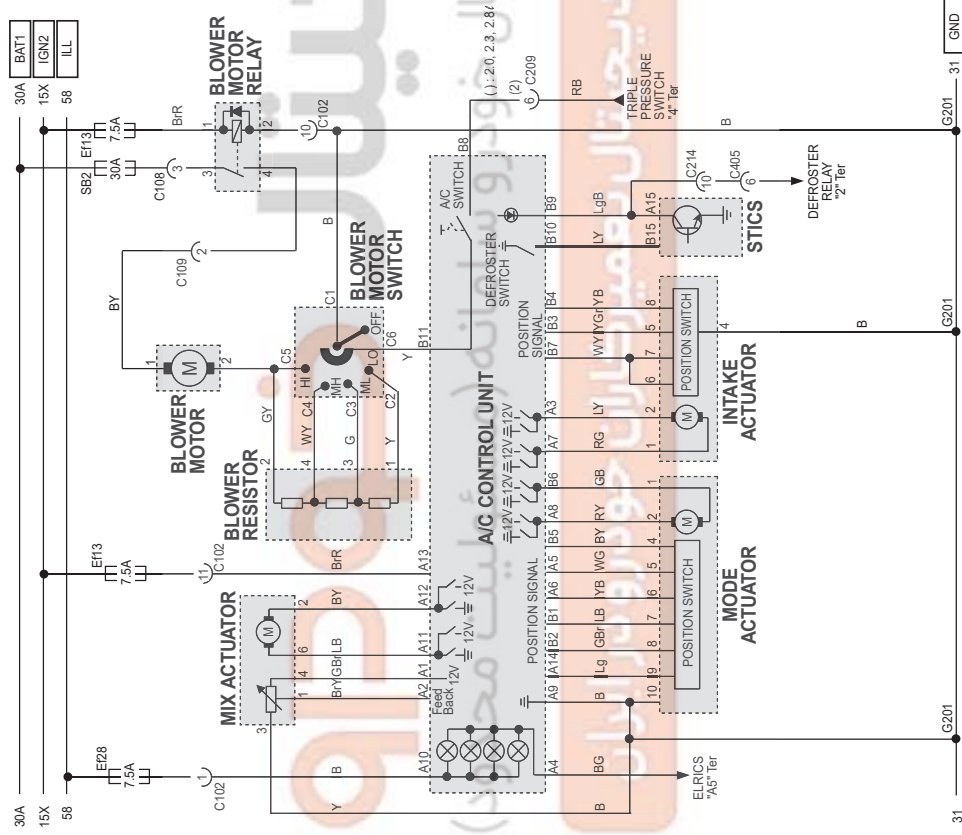

a. CONNECTOR INFORMATION

CONNECTOR NUMBER	WIRING HARNESS	GROUND POSITION
G201	Main	Above Driver Seat Leg Room

b. CONNECTOR IDENTIFICATION SYMBOL & PIN NUMBER POSITION

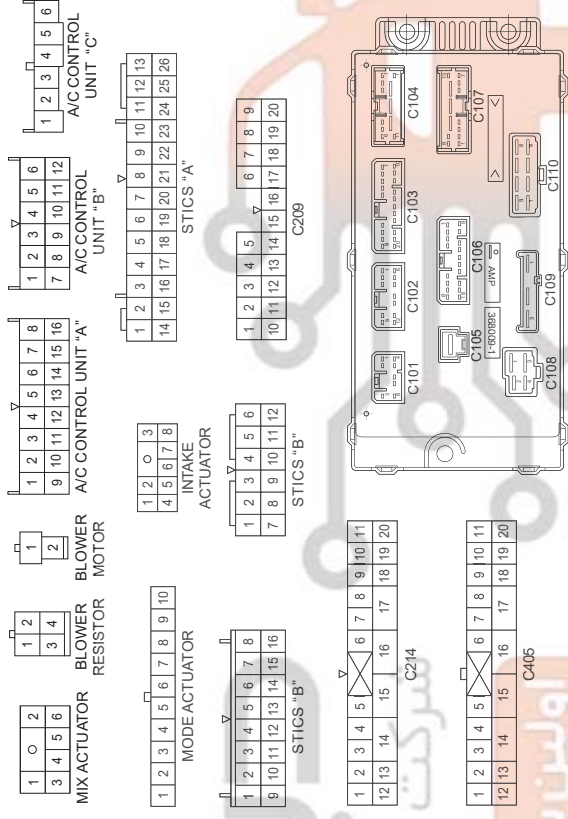

C. POSITION OF CONNECTORS AND GROUNDS

• W/H MAIN : FRONT

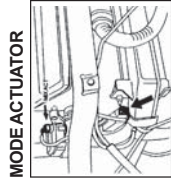

MODE ACTUATOR

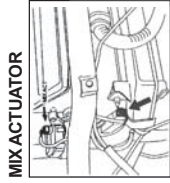

MIX ACTUATOR

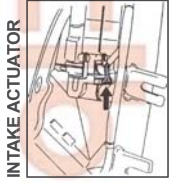

INTAKE ACTUATOR

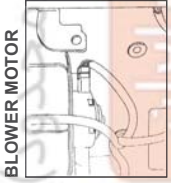

BLOWER MOTOR

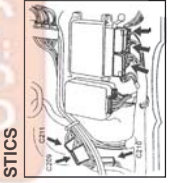

STICS

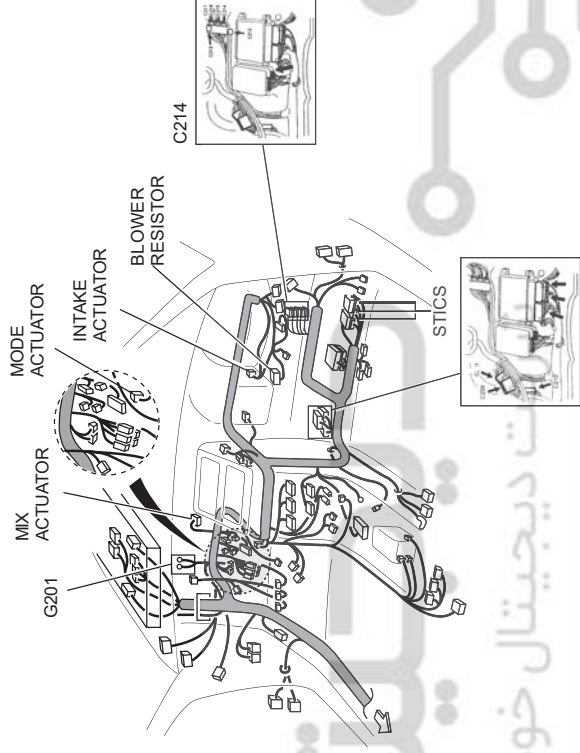

C209

• W/H FLOOR : TRUNK

• W/H FLOOR : CO-DRIVER SEAT

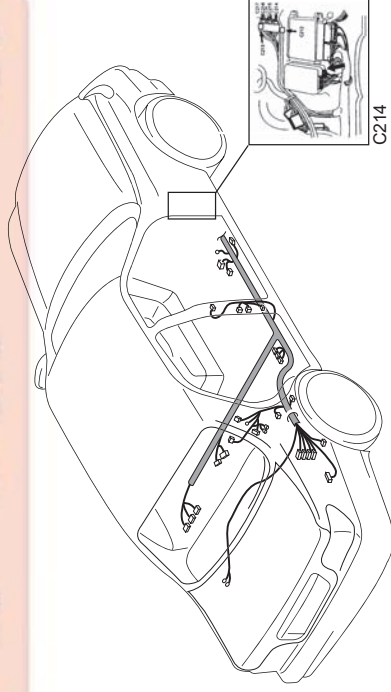

C214

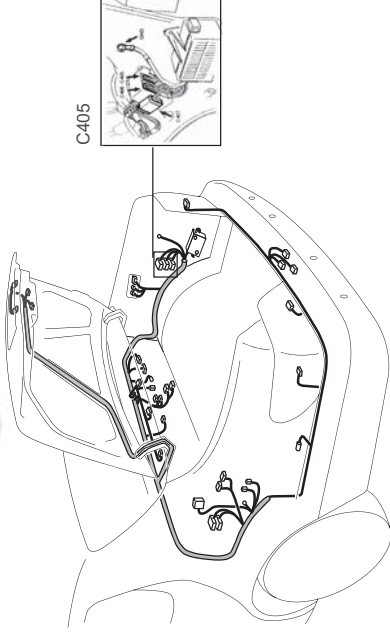

C405

